

# WALLTOPIA

## HARMONIZED WALLS

A universal platform for route sharing between climbing gyms





# Harmonized Walls Concept

The key to a successful climbing gym lies in the good route setting.

The growing popularity of indoor climbing and the rapid expansion of the industry has led to shortage of quality route setting. The number of climbing gyms has increased tremendously in the recent years while the number of skilled route setters hasn't been able to keep up the pace - the workforce simply can't meet the needs for quality route setting in all the gyms.

Walltopia Harmonized System aims to optimize the way route setting is being done. The Harmonized system is a universal platform that brings a healthy dose of standardization by giving the opportunity to set routes that can be replicated around the world and allowing climbers to give feedback about those routes through a mobile app.

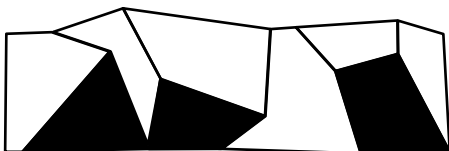

**INCORPORATE  
MODULES FROM THE  
HARMONIZED SYSTEM  
IN YOUR GYMS**

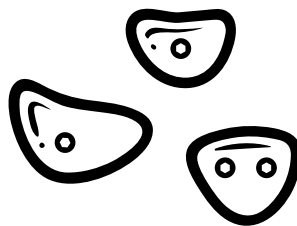

**USE THE STANDARD  
SETS OF HOLDS ON  
THOSE BOULDERS TO  
CREATE ROUTES**

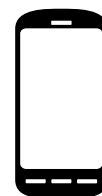

**SHARE THE ROUTES  
ON E-WALLS, SET  
THEM IN DIFFERENT  
LOCATIONS & RECEIVE  
FEEDBACK FROM  
YOUR CLIENTS**



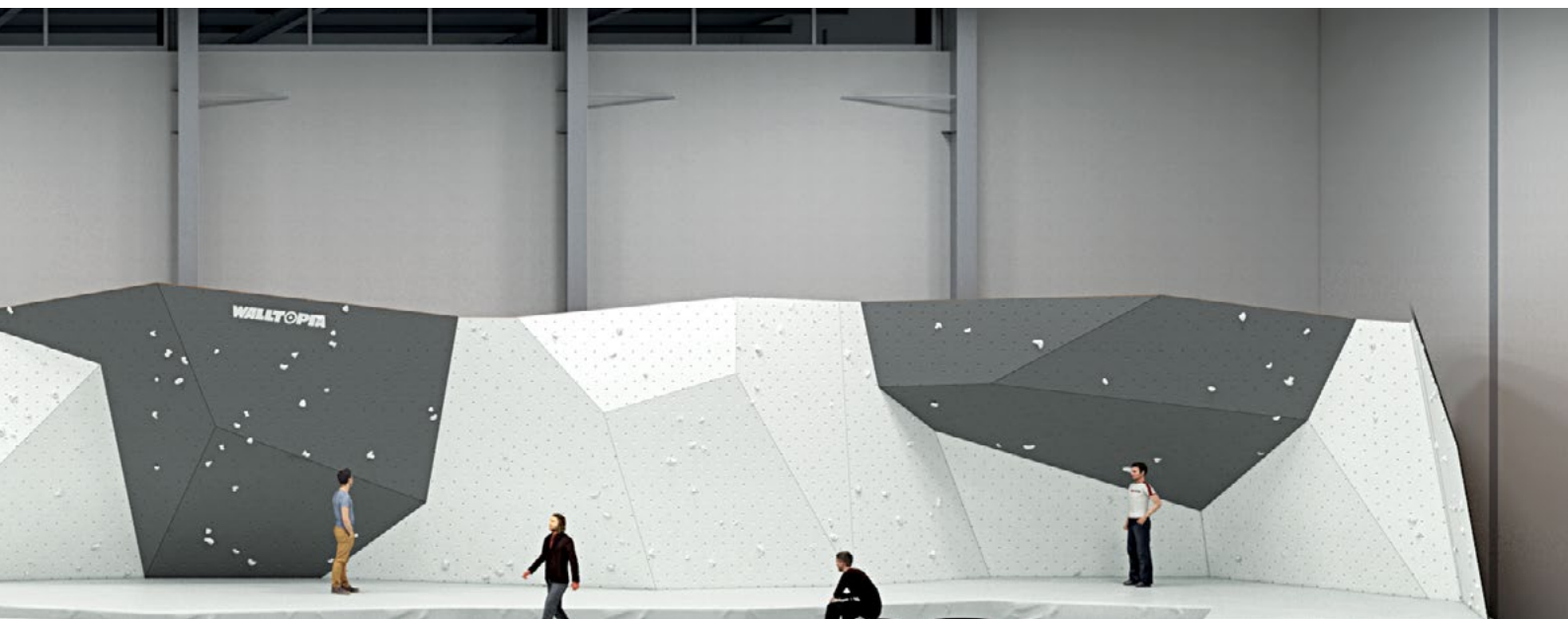

# Benefits

## FOR THE CLIMBING GYM OWNER:

- Get immediate access to a database with quality routes online.
- Offer your clients greater diversity of routes at a low cost.
- Replicate routes throughout multiple locations.
- Boost your expansion plans without facing lack of experienced route setters in all of your locations.
- Receive feedback from the end customer about the routes in your gym(s).
- Reach your clients easily through the mobile app and alert them about new routes.

## FOR THE ROUTE SETTER:

- Create routes that can be sold online to a climbing gym on the opposite side of the world.
- Build a name in the industry by creating quality routes that people like.
- Receive feedback about your work from the end customer.
- Manage route setting in multiple locations from your mobile device.

## FOR THE END CUSTOMER / CLIMBER:

- Climb a diverse selection of routes set by the best route setters worldwide in your local gym.
- Log your climbs and track your progress, see stats about your training.
- Follow fellow climbers, try the routes they like and compare your achievements to theirs.
- Receive news from the gyms you follow and get notifications about new routes.
- Give feedback to your local climbing gym about the routes you enjoy and help them improve their service.

# Design Features

## VARIETY OF ANGLES

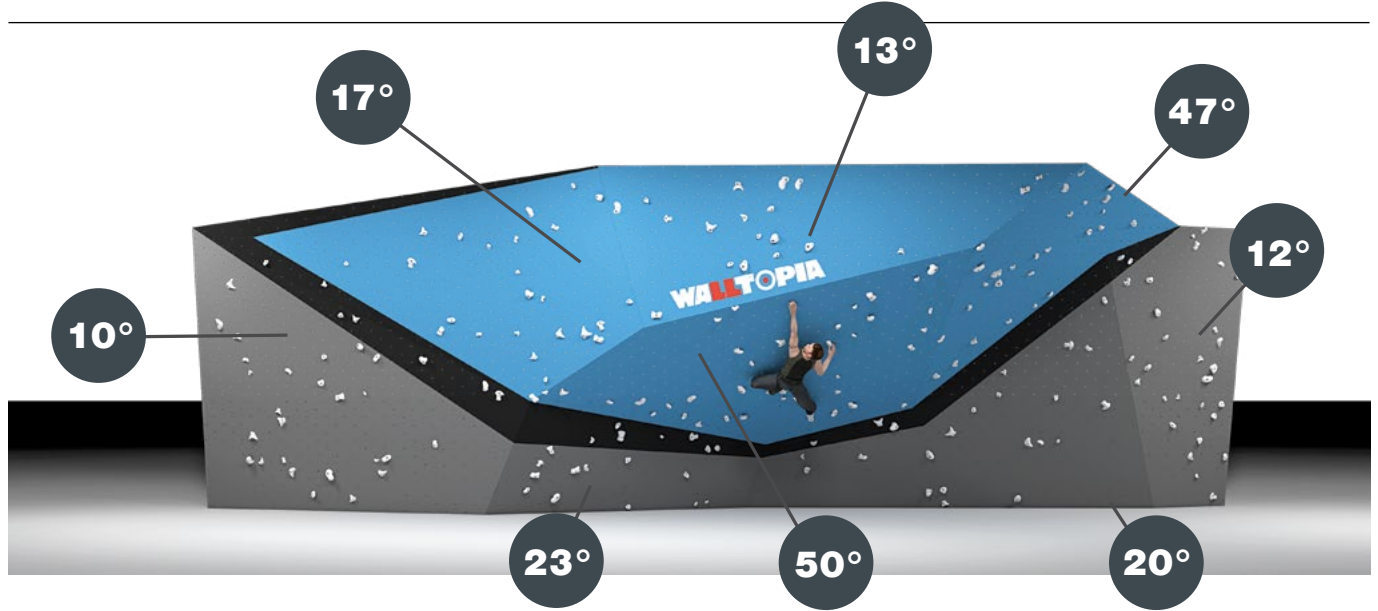

## BIG PANELS



## SMOOTH TRANSITIONS

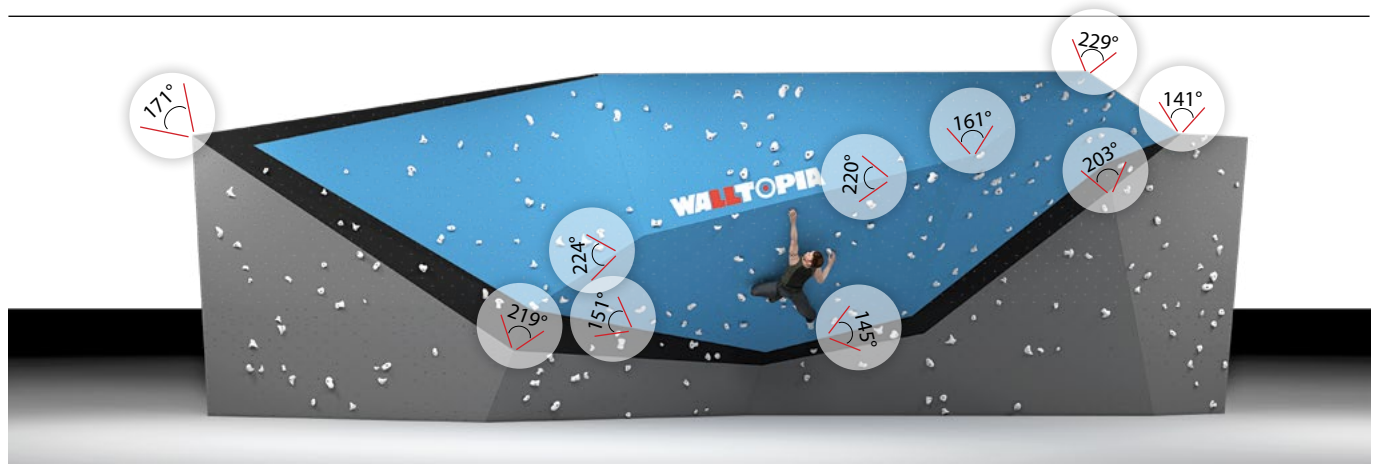

# Design Features

## EASY INTEGRATION IN ANY GYM

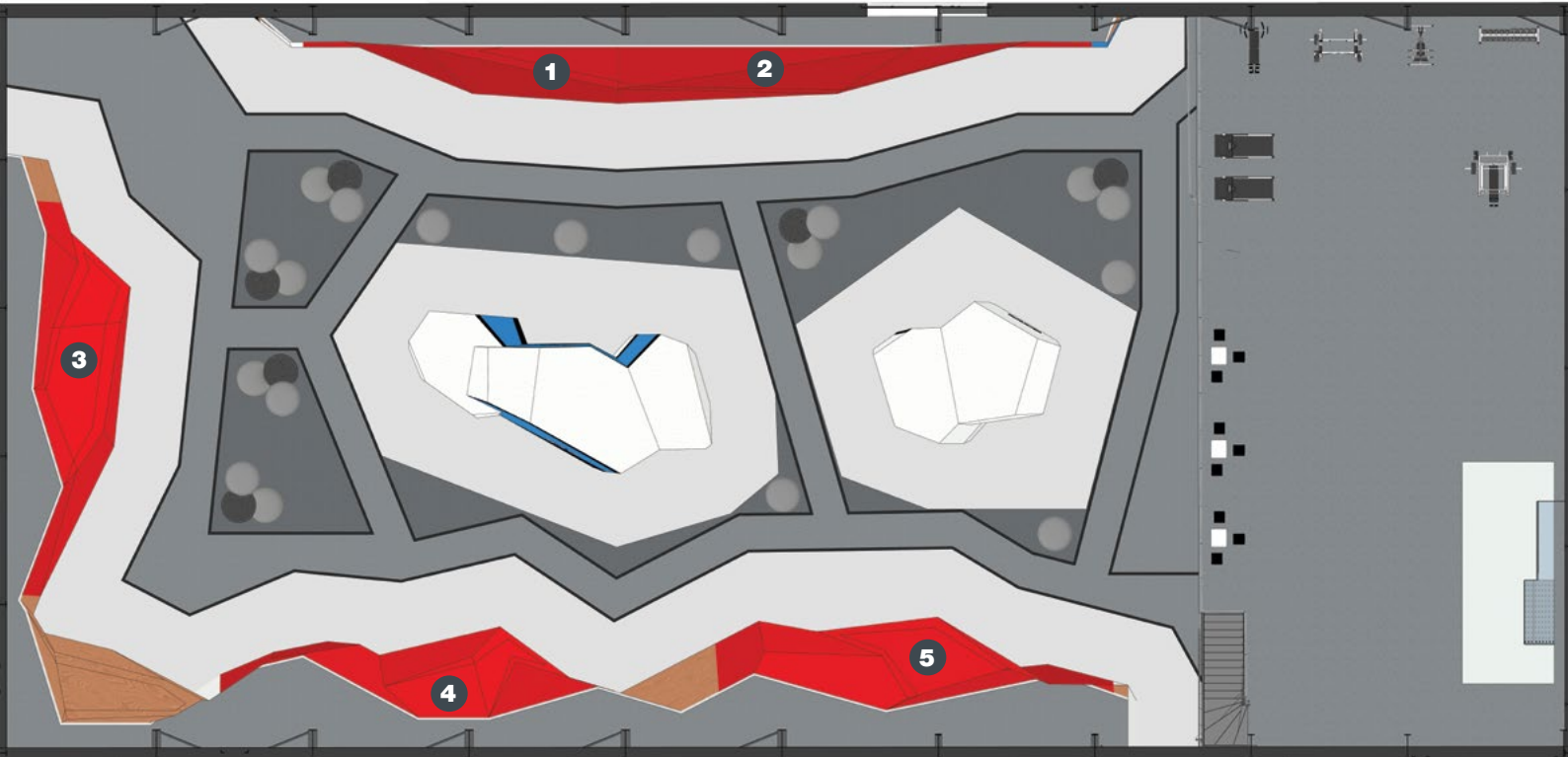



# Harmonized Module 1

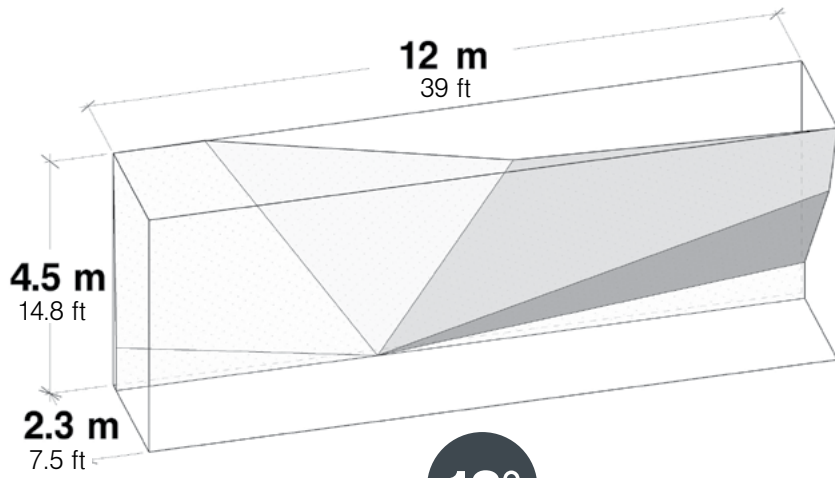

CLIMBING SURFACE
<b>58.2 m<sup>2</sup></b>
626.5 ft <sup>2</sup>



# Harmonized Module 2

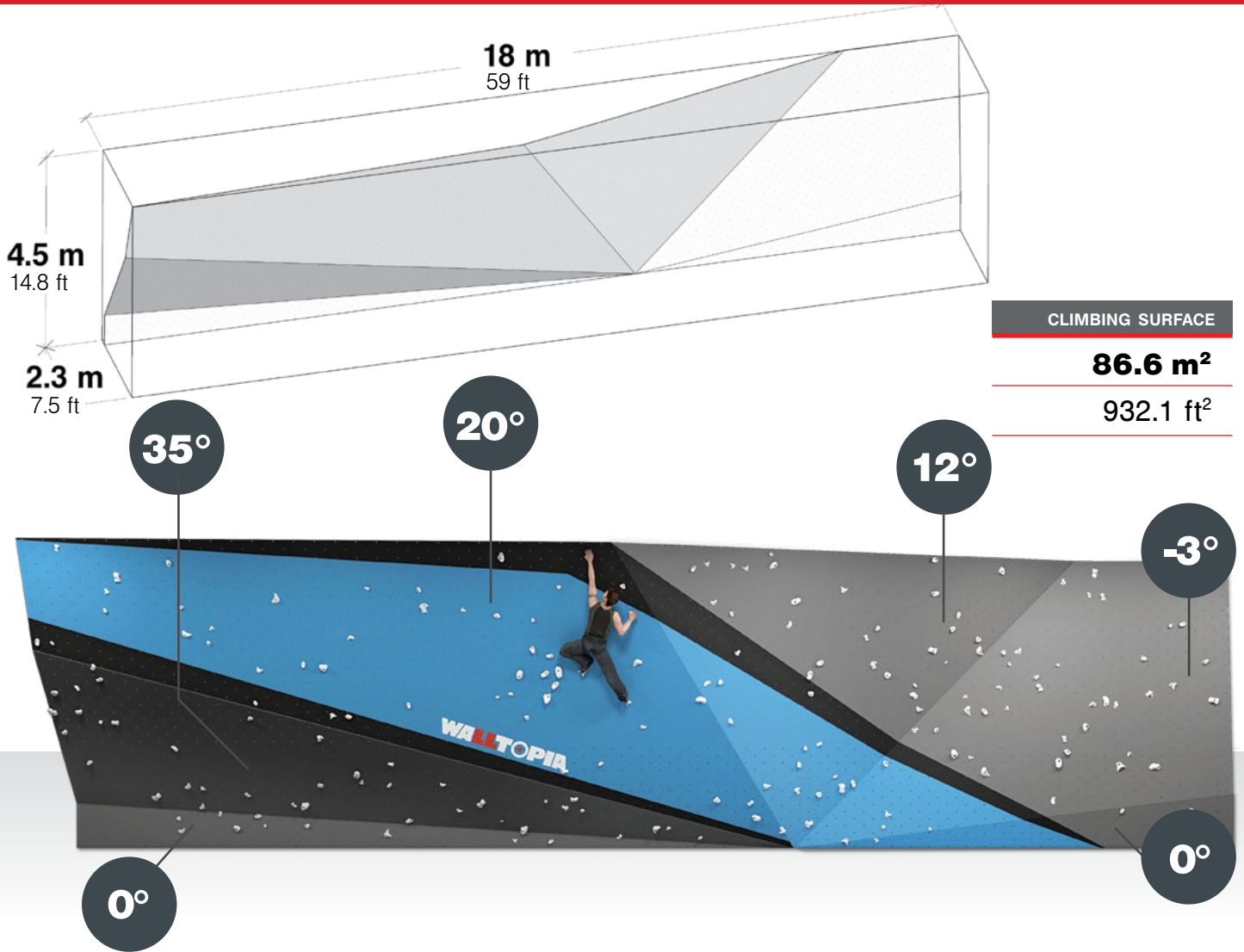

## World Championships Innsbruck Finals Boulder





# Harmonized Module 3

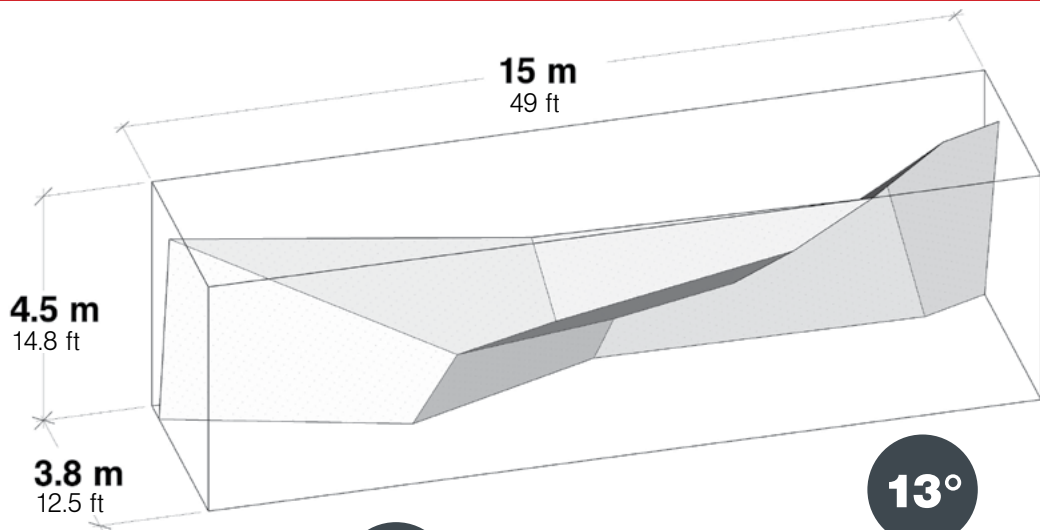

CLIMBING SURFACE
<b>78.5 m<sup>2</sup></b>
845 ft <sup>2</sup>

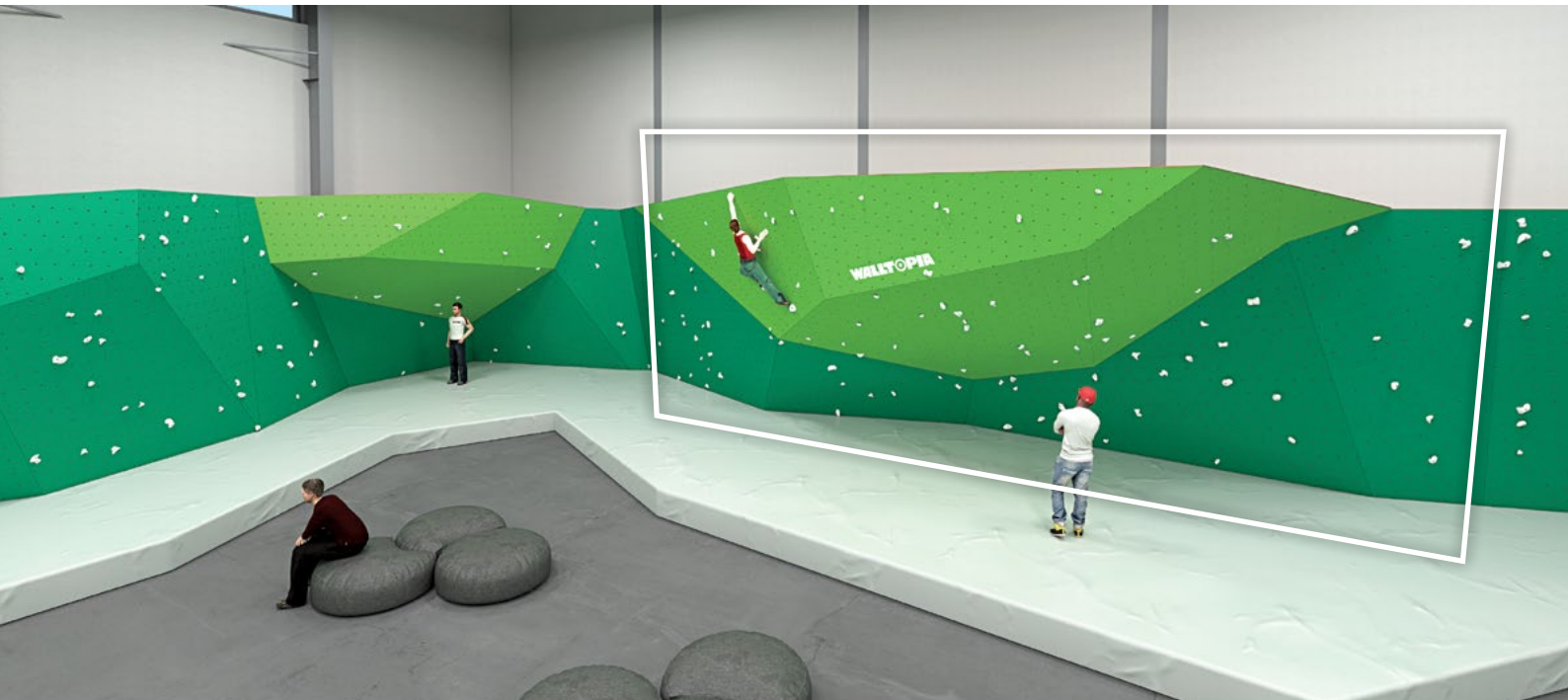
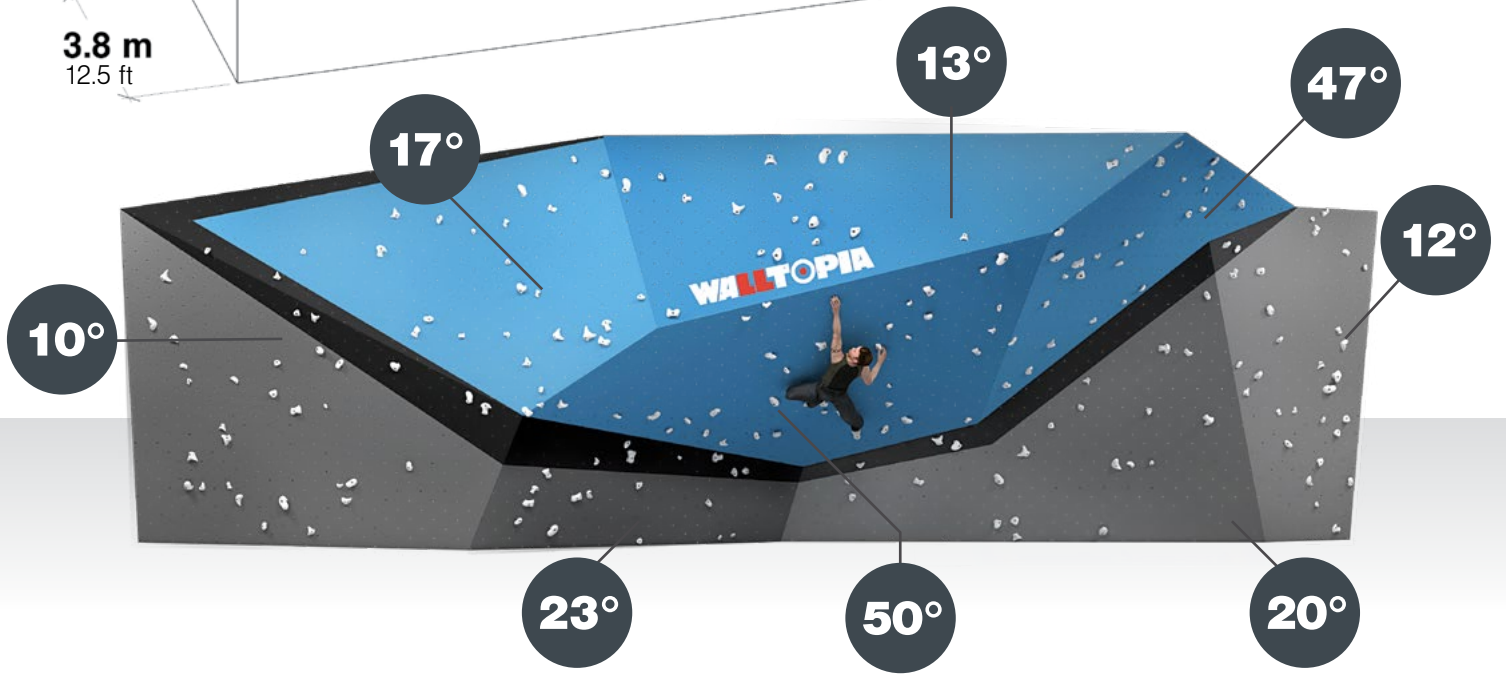



# Harmonized Module 4

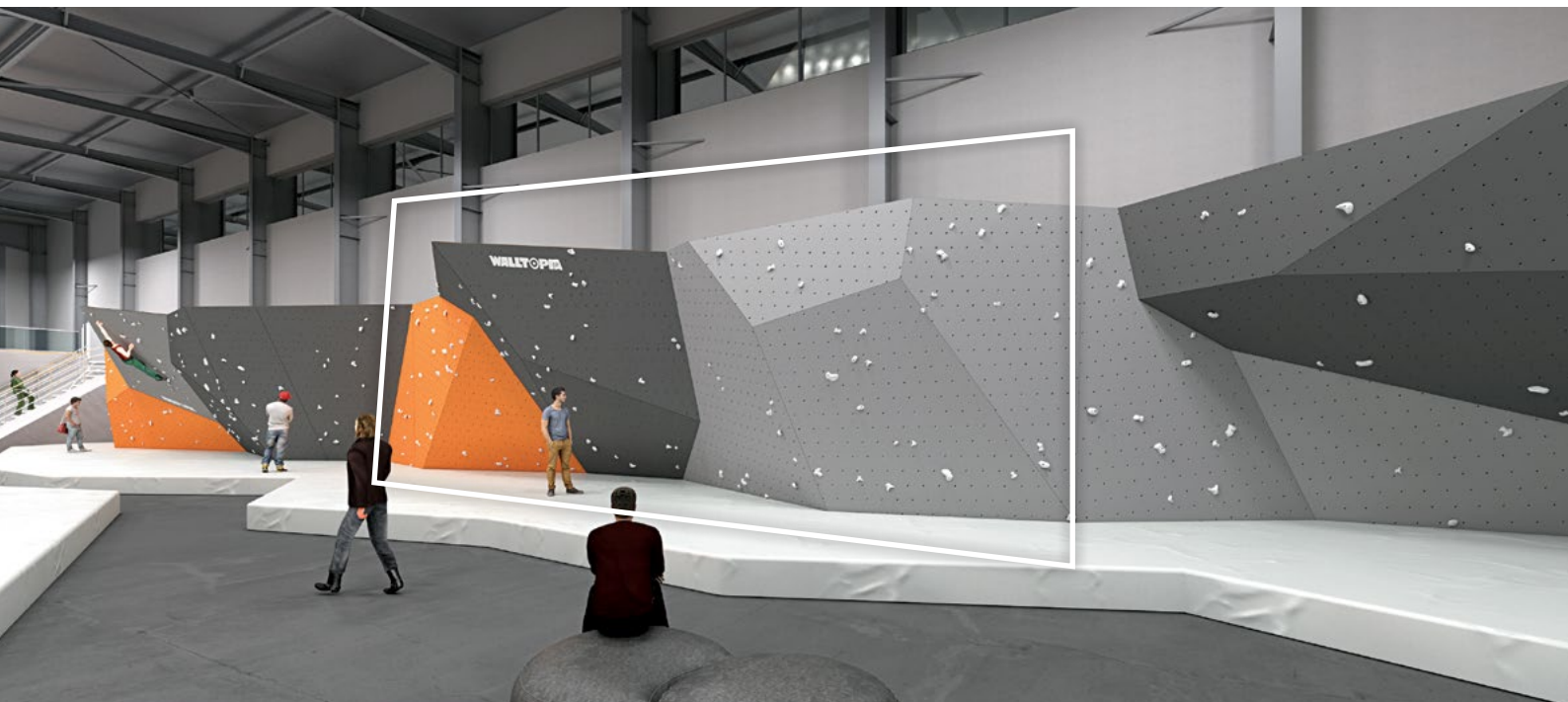
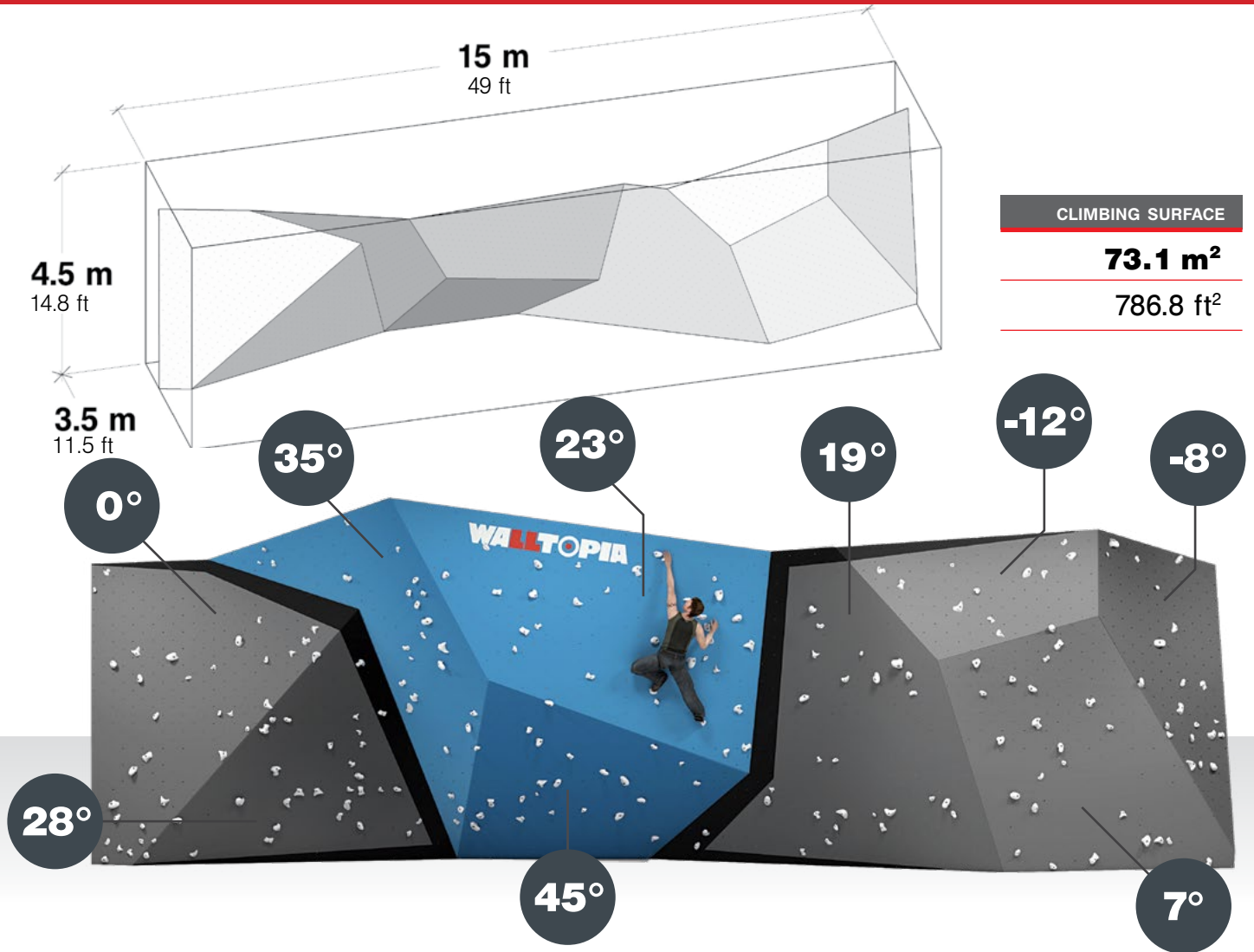

# Harmonized Module 5

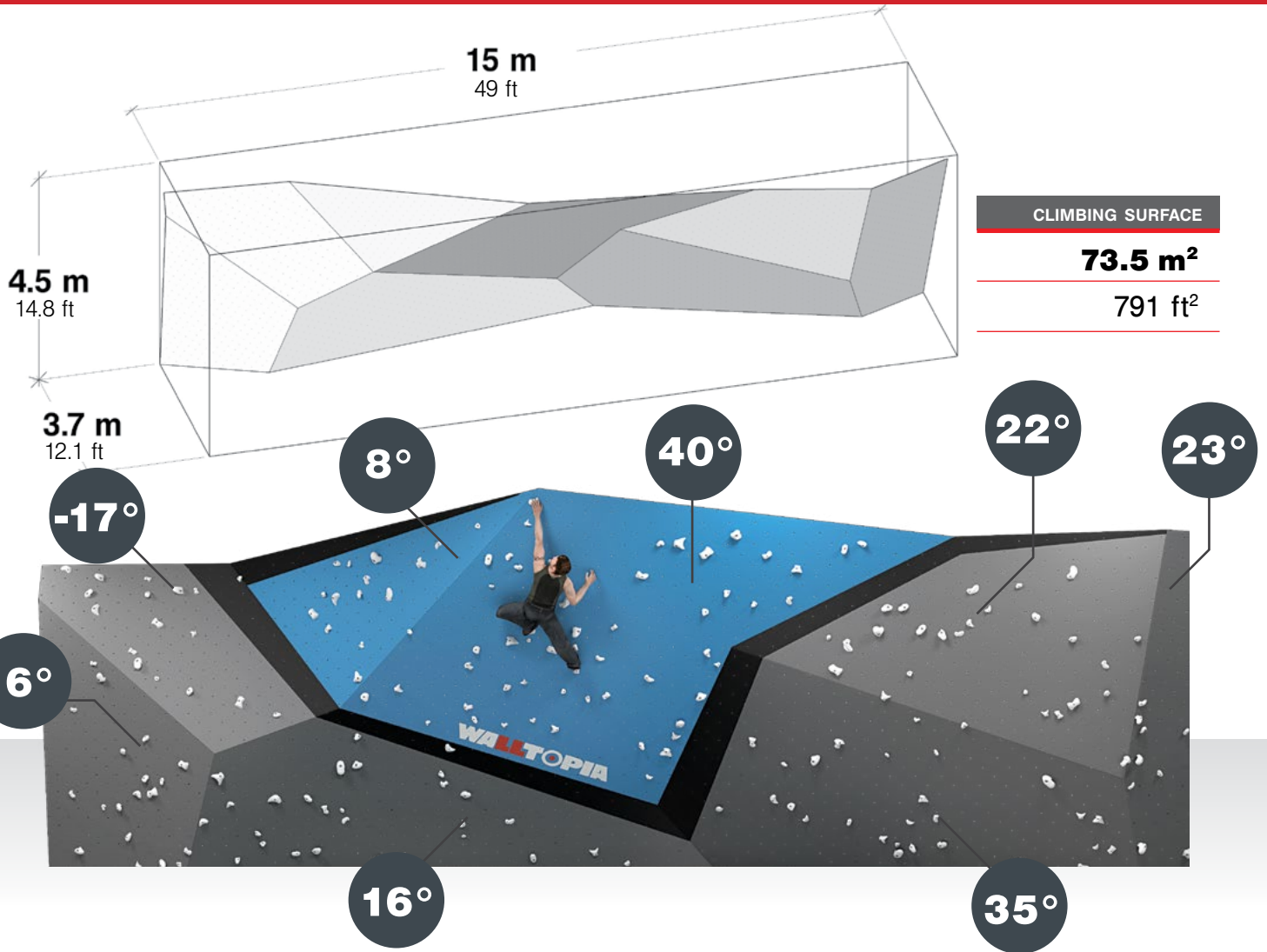



# Harmonized Module 6

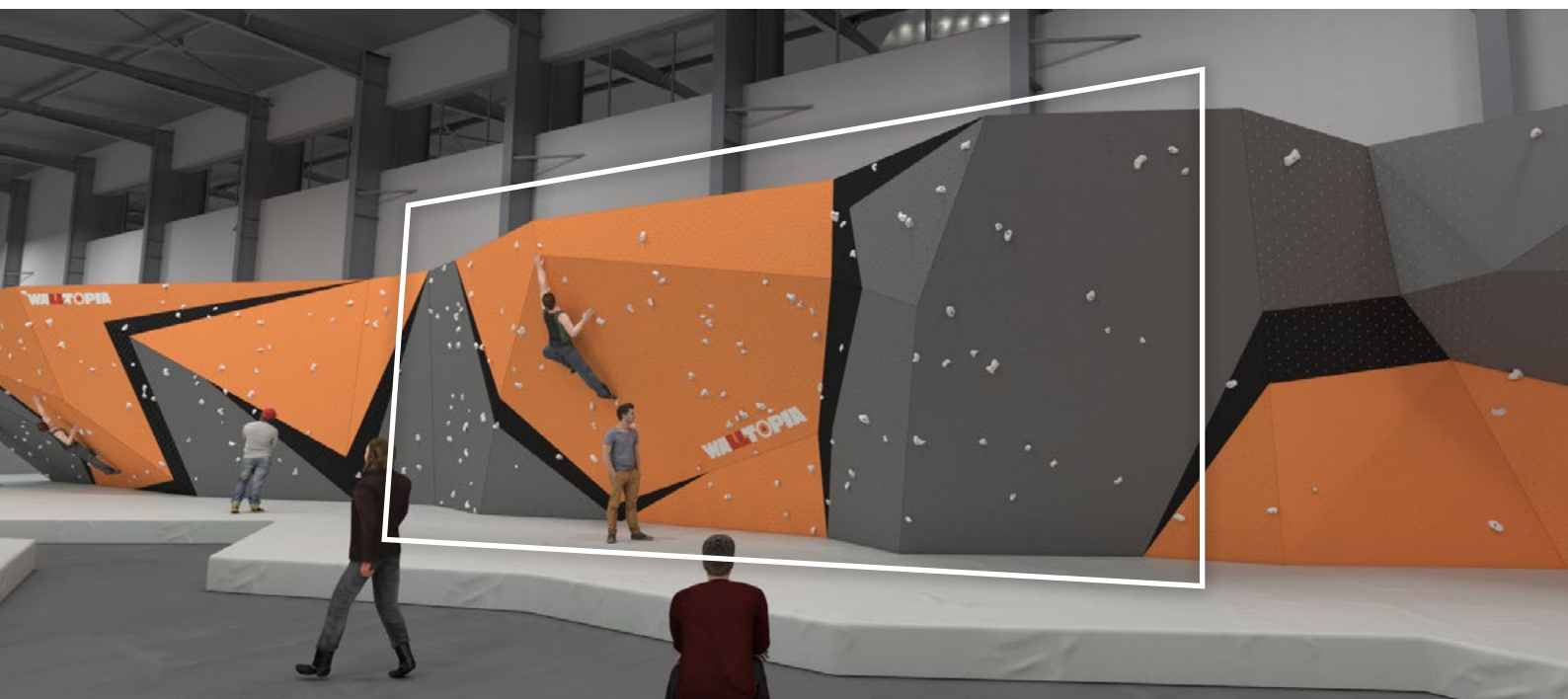
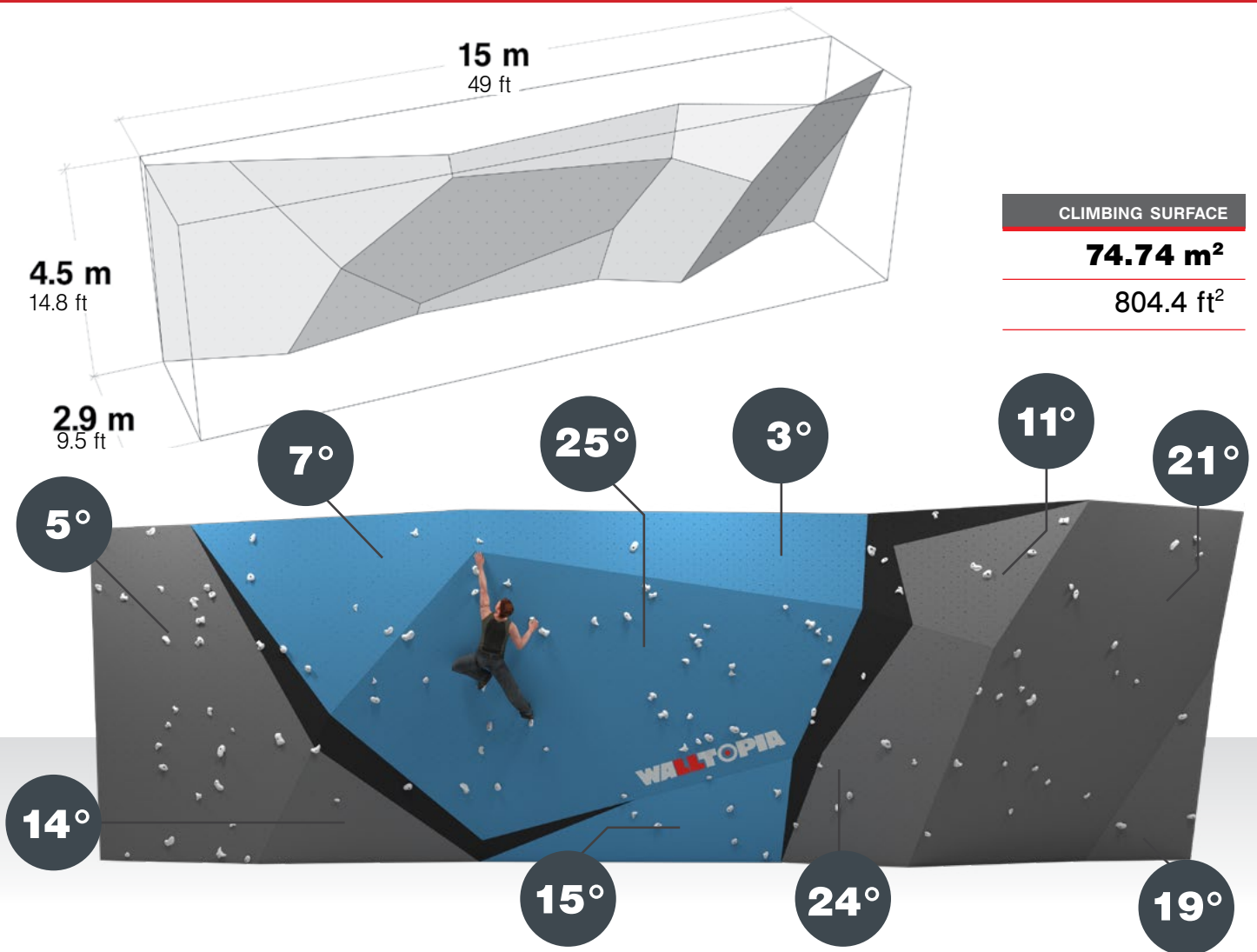

# Harmonized Module 7

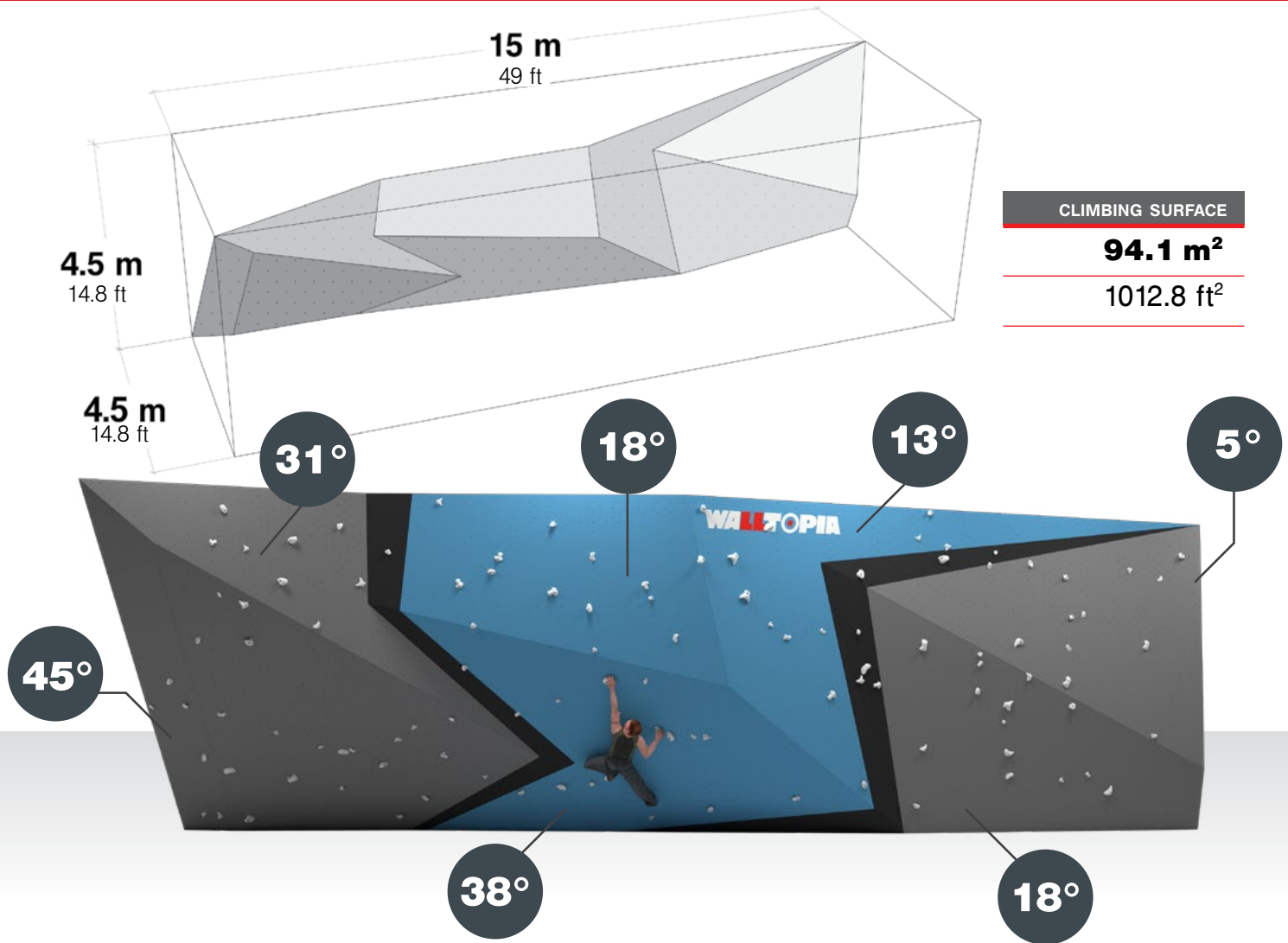



# Apply Unique Colors

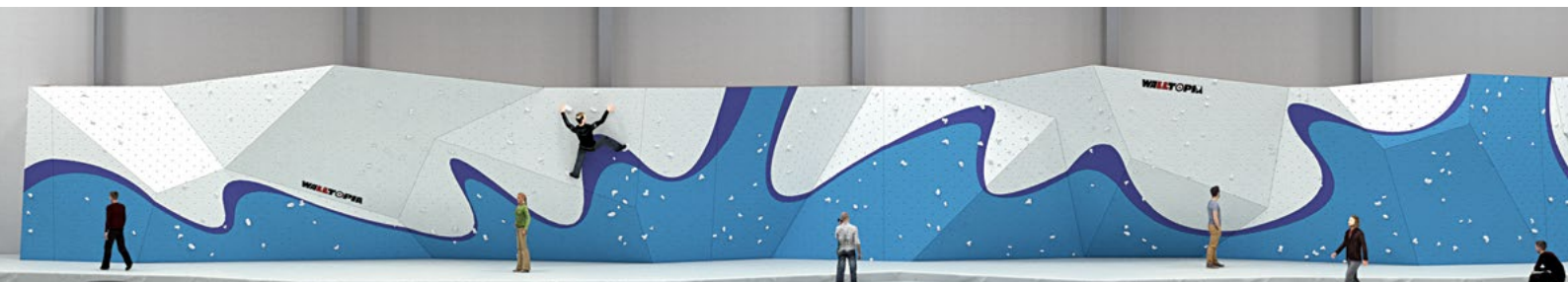

# Software

Custom developed software serves all three user groups of e-walls via different modules with different access levels made to suit the needs of each one of them.

## CLIMBERS APP

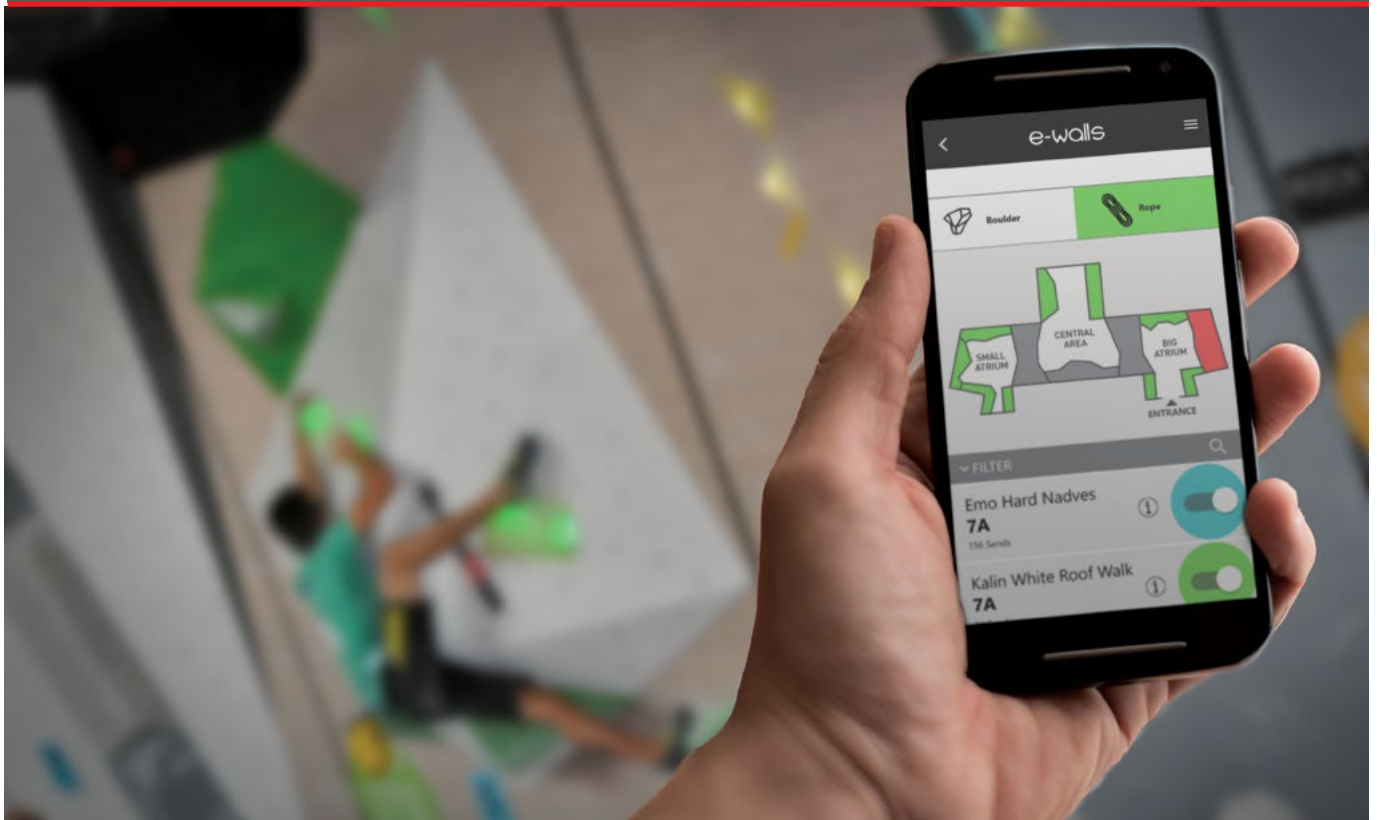

*A mobile app serving the climbing gym's end customer - the climber. It provides a catalogue of the present routes, achievement tracking system and feedback for the gym owner.*

- Download the app for iOS or Android on your mobile device.
- See an overview map of the gym, search and activate the routes available in the gym.
- Easily find the routes available at the lines in front of you in the grade range you prefer.
- Log your climbs and track your progress. Compare your achievements to peers.
- Give feedback to your gym about the routes and help them improve their setting.
- Follow climbing gyms and climber friends and get notifications for updates.



## ROUTESETTERS APP

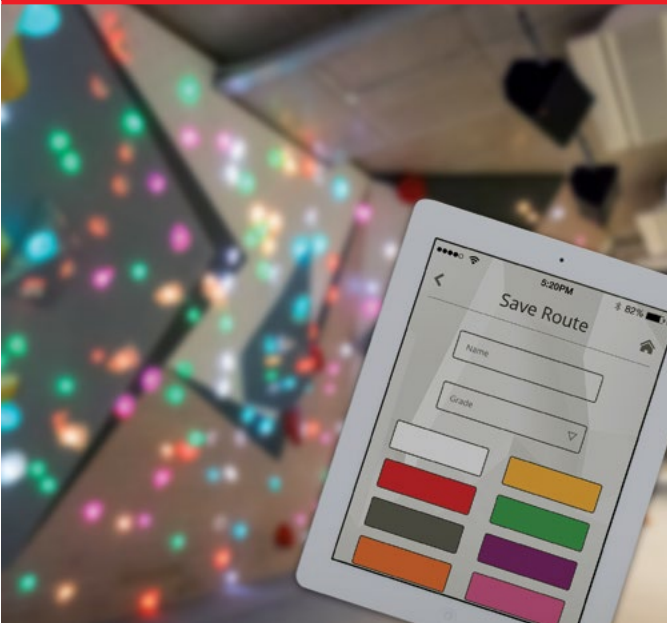

*A mobile app serving the route setters. It features a database of all the holds available, interactive tool for lighting up and managing the active routes and archive of routes.*

- Create routes and share them online.
- Manage the route setting at multiple locations.
- Access already created routes, download and edit them.
- Receive feedback from the end customers through the mobile app.

## GYM DASHBOARD

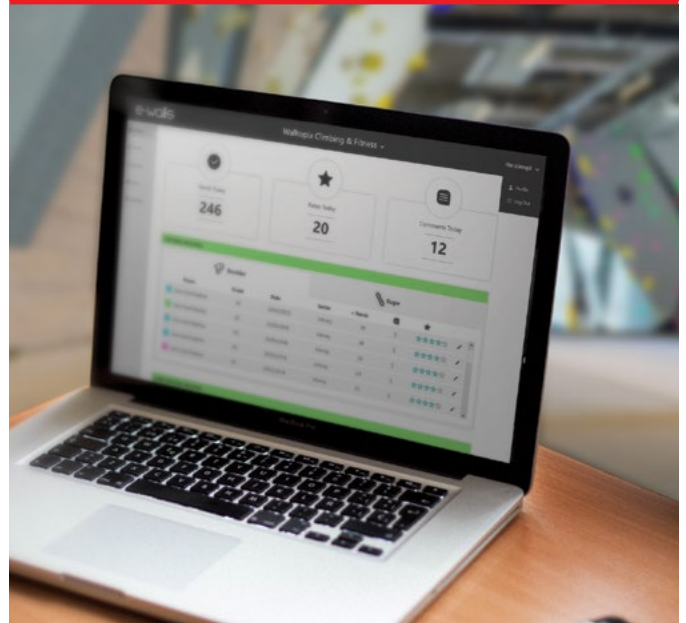

*A desktop app serving the gym owner and manager. It features routes management system and stats about the user activity in your facility.*

- See statistics about the popularity of the routes in your gym and get feedback about your clients' preference.
- Easily manage the routes in the gym and notify your users for new routes.
- Create more social activity in your gym and web presence.
- Get a map and list of routes embedded in the website of the gym. It can be customized according to every website design.

# Hardware

Custom engineered hardware developed to serve the purposes of e-walls and the Harmonized system consists of the following units:

## RGB LED NODES



- Installed on the climbing panels
- Placed by every t-nut at a density of 36 per sq.m (4 per sq.ft)
- Offering a wide range of possible colors

## CONTROL BOX

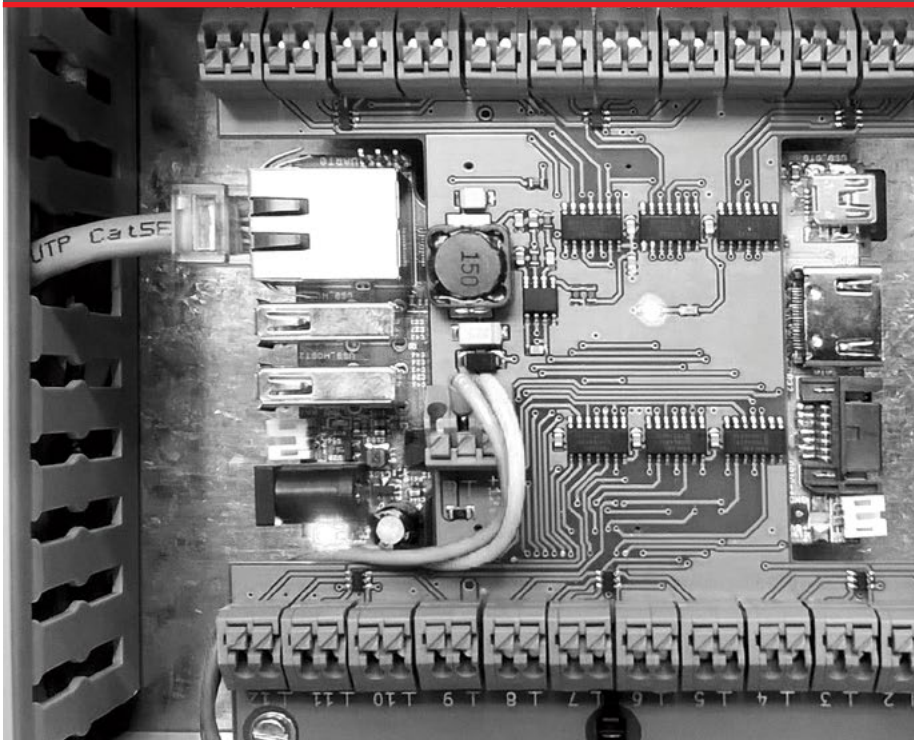

- Each box controls up to 215 sq.m (2314 sq.ft) of climbing surface
- Multiple control boxes utilize bigger areas
- Easy to maintain: each component can be easily replaced



## DESKTOP SERVER



- Contains the local database and local app controlling the hardware.

## ROUTER



- Serves for connection point between the local server and control box. Provides access to the cloud database.





