

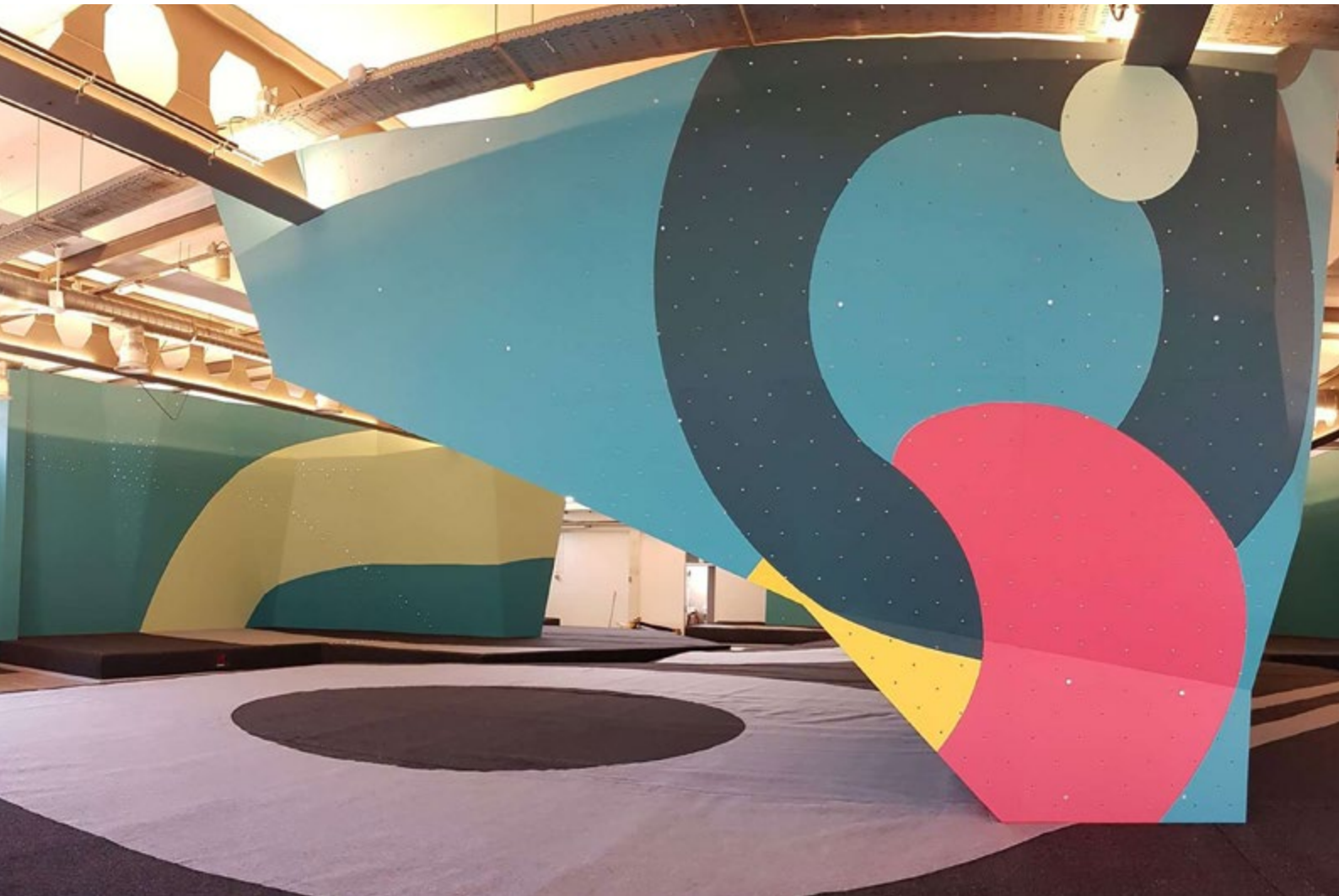

FLOORING SOLUTIONS



a brand of **WALLTOPIA**

ABOUT THE COMPANY



We are a high quality safety mats manufacturer. Our products are designed and engineered for climbing gyms, sports centers and facilities for active entertainment. We offer a broad range of products suitable for a variety of purposes.

Climbmat is a company from the Walltopia group – the leading manufacturer of artificial climbing walls. Owned and run by a team of engineers, Climbmat is proud of its serious investment in the R&D department led by a Ph.D. physicist who is also a climber aware of the needs and expectations of the market. Ever since our foundation in 2012, our production capacity has been steadily growing in order to match the global demand. For the last year alone we have produced more than 16000 square meters of safety mats, and other products from our range of more than 500 different items.

Furthermore we are always developing new products, and try to work closely with gym owners and climbers in order to improve both the safety and longevity of our products.

We offer a complete solution, including precise measurement, manufacturing, delivery, installation and after-sale services. Our mission is to provide a safe climbing environment for every gym in the world by improving the current flooring systems and developing new superior products. This is precisely why research and development are our top priority. Our mission is to provide a safe climbing environment for every gym in the world by improving current flooring systems and developing new quality products. This is precisely why research and development is our top priority.

THE CLIMBMAT QUALITY

Safety and quality are the two major driving factors behind the development of our products. They always go hand in hand in order for us to deliver an excellent product. Our R&D, engineering and production teams, are always working to improve those two factors. Besides incorporating new and improved materials, we are always trying to improve the finishing details as well, which in our opinion helps deliver a good, well rounded product. Maintaining most of our production in-house, helps us sustain our quality.



Heat Welding

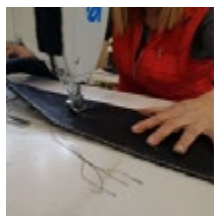

Heavy-duty sewing



Gluing



Upholstery



Carpentry

THE PROCESS



Pre-measuring and Engineering

Accurate measurements of your premises are required in order to precisely define the flooring need. Once we have the correct measurements of the climbing wall contour and height, the best type of flooring can be determined. Our engineers then proceed to drawing and designing the minimum required safety zone as defined by the EN 12572-2 standard. We also offer precise 3D laser scanning which is highly recommended for 100% accurate drawings.



Production

Climbmat boulder and rope wall mats are produced in a hi-end production plant under the direct supervision of the engineering and R&D team in compliance with the latest safety standards around the globe, in order to ensure maximum safety for the climbers.



Delivery

Climbmat ships safety mats to any spot in the world.



Installation

A team of experienced technicians is sent to each location to execute the installation of the flooring system. Insulation panels are placed in every gym beneath the mats to protect them from humidity.



Warranty

Climbmat gives an 18-month warranty for all products.

DEVELOPMENT

All of our products are developed and tested following the different safety procedures and standards around the globe. Furthermore we test all of our safety flooring using a precise human analog – Hybrid II human crash test dummy - in order to ensure maximum safety for the climbers:

EU	US	AUSTRALIA
<ul style="list-style-type: none"> • EN 12572-2 • NF P90-311 • NF P90-312 	<ul style="list-style-type: none"> • ASTM F355, Part E • Analog to EN 1176 	<ul style="list-style-type: none"> • AS 2316.1
<p>Accelerometer drop tests:</p> <ul style="list-style-type: none"> • Impact deceleration • Energy restitution • Mat compression 	<p>Accelerometer drop tests:</p> <ul style="list-style-type: none"> • Maximum G-Force • HIC 	<p>Accelerometer drop tests:</p> <ul style="list-style-type: none"> • Determination of HIC • Maximum G-force • Delta-t

THE DESIGN

Every Climbing and Bouldering gym is unique. Guided by safety, we adapt the matting design around that of the climbing wall. As a minimum we follow the fall or safety zones set by the existing standards, around the globe. In many instances we recommend going beyond them in order to ensure the best protection for climbers and to accommodate for the latest design, route setting and climbing trends.

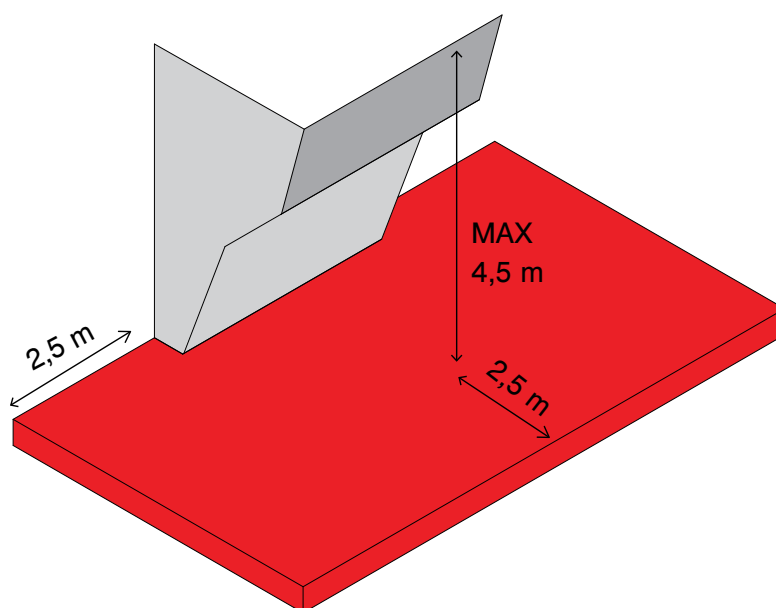

The tools at our disposal and our experience helps us successfully bring the 3D model to reality.

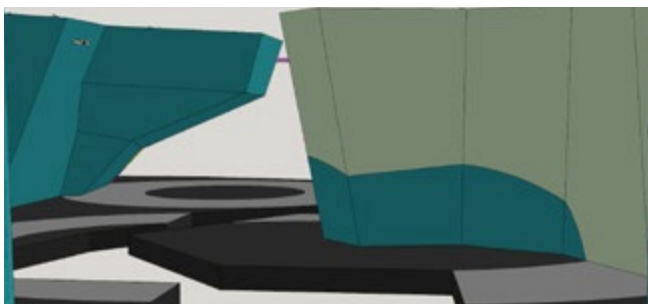

3D Model



Reality



THE MATERIALS

PVC VINYL

High strength, high value, waterproofed, UV-resistan, PVC coated polyester fabric – a.k.a Vinyl.

Tech specs:

- Total weight: 900 g/m² (26 Oz)
- Tensile strength: 4300/4000 N/50 mm (430 / 400 lbs. / in)
- Tear strength: 500 N (70 / 90 lbs.)
- Temperature range: -40 °C / +70 °C (-40 °F / +158 °F)
- Fire behavior: <100 mm/min. (acc. ISO 3795)

Materials with higher fire ratings are available upon request. They are compliant with the following fire standards: BS 7837, DIN 4102: B1, NFP 92507: M2, EN 13501-1: B-s3-d0, GOST: G1, D.M. 26.06.84 (UNI 9177): CL. 2



Additional colors are available upon request. Please contact our sales department for more information on the currently available colors.

CARPET

Commercial grade, high-traffic optimized needlepunched carpet.

Tech specs:

- Total weight: 750 – 1050 g/m² (22 - 31 Oz)
- Fibers: 100 % polypropylene
- Noise Reduction: 17 – 20 dB
- Fire behavior: C_{fl} (acc. EN 13501-1)

Materials with higher fire ratings are available upon request - B_{fl} – according EN 13501-1

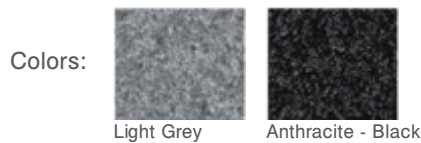

Additional colors are available upon request. Please contact our sales department for more information on the currently available colors.

THE MATERIALS

FOAM

All of our products use only the highest quality polyurethane foams available, combining low impact for the climbers and low residual deformation for higher comfort and durability.

BALLISTIC NYLON

Thick, high strength durable nylon fabric, originally developed for military purposes. This material is available with limited quantities, as an alternative to vinyl and carpet fabrics. Please contact us for availability and more information.

VINYL VS. CARPET

VINYL 900 G (26 OZ)		CARPET	
Pros	Cons	Pros	Cons
Very durable and flexible material	Very hard to clean climbing shoe rubber marks	Very easy cleaning	Less durability compared to vinyl
Does not hold odors	Does not hold the chalk and requires a lot of maintenance to keep the wall clean.	Holds the chalk, which can be easily removed upon cleaning	Holds stains and odors, if not cleaned on a regular basis
Spill resistant		Comfortable feel, creates cosy atmosphere	Less flexible than vinyl, can cause warps and wrinkles over time
Few or no seams	No noise absorbtion	Strong noise absorbtion	Velcro seams every 2-4 m that are a weak spot and might need replacement

THE TESTING

TESTING PROCEDURE

All of our products are developed and tested following the different safety procedures and standards around the globe. Although not required by the standards, we also tests all of our safety flooring using a precise human analog – Hybrid II human crash test dummy - in order to ensure maximum safety for the climbers.



EN 12572-2 Impactor
Test mass: 30 kg
Object diam.: 150 mm
Drop height: 2.2 m



2 x 2 m (6.5 x 6.5 ft) Test Sample



Hybrid II Crash test dummy



The drop

TEST RESULTS

EN 12572-2 Impact Test

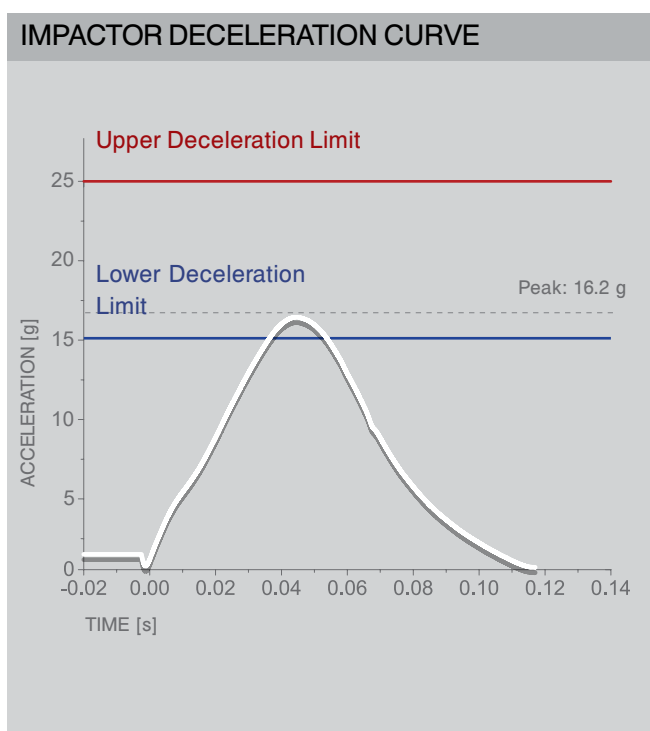

EN 12572-2 standard test. The standard impactor is dropped multiple times on specific locations. The impactor is raised to the specified height and then dropped. The deceleration curve of the test's mass upon impact is measured using an integrated 3-axial accelerometer. The following parameters of the mat are determined:

- Peak Deceleration
- Resilience
- Deflection

Crash Test Dummy Test

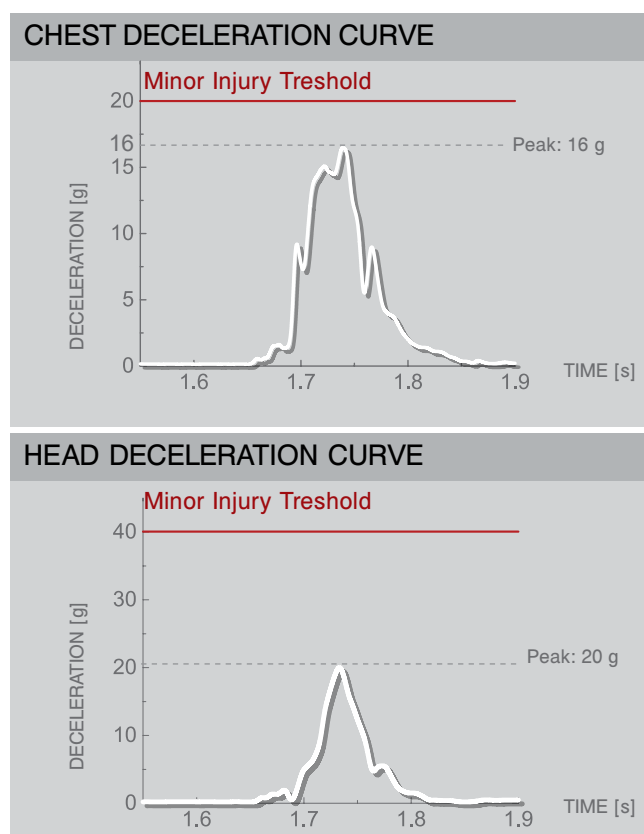

Using a more accurate human analog – Hybrid II crash test dummy – we conduct a series of drop tests on our products, in order to develop a product, which is much safer for the climbers. The dummy is drop from heights up to 2.5 m and 3.5 m, depending on the position of the fall (falling on its feet or its back) The deceleration curves of the tests object, upon impact, are measured using two integrated 3-axial accelerometers. The following parameters of the mat are then determined:

- Peak Chest Deceleration
- Peak Head Deceleration
- Head Injury Criterion (HIC)

*The shown test results are for BM400

BOULDER MATS

ONE COVER VINYL CONSTRUCTION

Our one cover option features seamless cover over the whole area. It is an advisable very durable solution for large areas. The flooring is non-removable, and requires an experienced crew for installation / deinstallation and repair.



MODULAR VINYL CONSTRUCTION

Our modular option features modules customized for your wall, connected with PVC vinyl velcro lids. Advisable solution for small areas, it is easy to install and/or repair even by an unexperienced crew. Weak on the connection points.

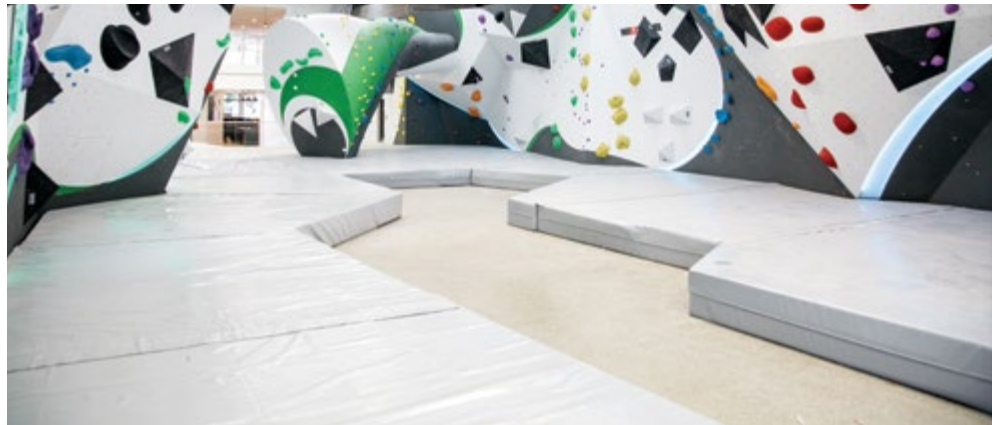

CARPET TOP FINNISH

In recent years, adding carpet on top of the PVC vinyl, regardless of the construction, became the norm, and not just an optional feature. The combination of vinyl and carpet, combines the pros of both materials, and minimizes the cons.

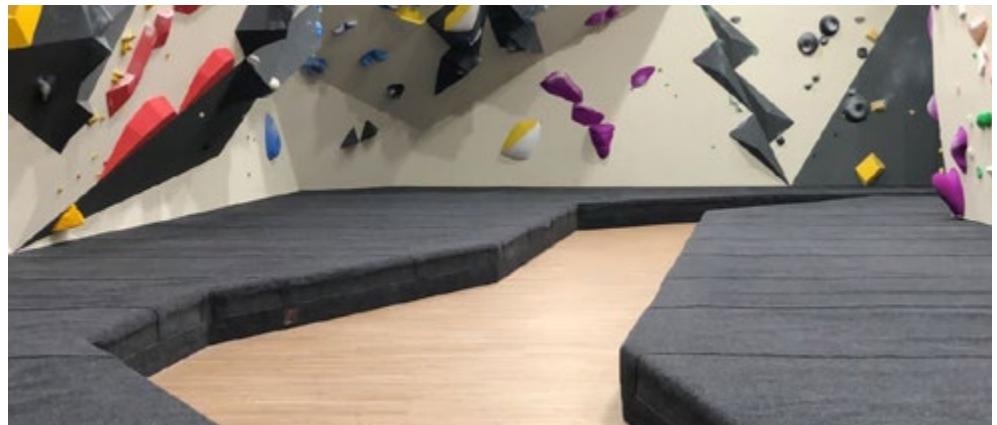

STANDARD FEATURES

Reinforced corners; Foam ventilation; No Gap system; Welded PVC connections; Double-stitched carpet connections.

OPTIONAL FEATURES

Harder edge; Handles; Partial carpet-covering (single strip to the wall); Dual-color carpet finish; Custom signs; Custom marking; Partial front edge carpet covering; Anti-slip bottom.

CONSTRUCTION & THICKNESS

BUDGET LINE

■ Low-density polyurethane foam 21-25 kg/m³

BM300S



ADVANTAGES

COMFORT ++ LIFESPAN +
SAFETY + PRICE -

■ Low-density polyurethane foam 21-25 kg/m³

BM400S



ADVANTAGES

COMFORT ++ LIFESPAN +
SAFETY - PRICE +

STANDART LINE

■ High density re-bonded polyurethane foam 90 kg/m³

■ Low-density polyurethane foam 21-25 kg/m³

BM300

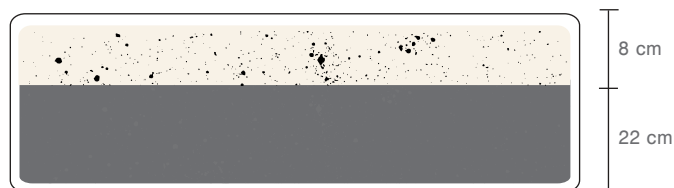

ADVANTAGES

COMFORT ++ LIFESPAN +++
SAFETY + PRICE ++

■ Mid-density polyurethane foam 30-35 kg/m³

■ Low-density polyurethane foam 21-25 kg/m³

BM400

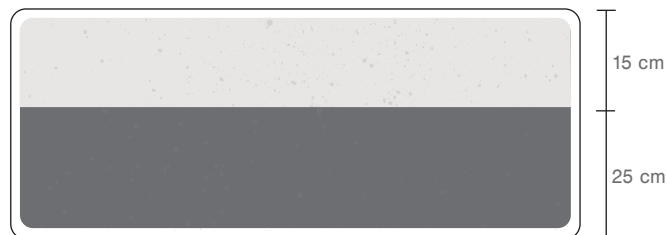

ADVANTAGES

COMFORT ++ LIFESPAN ++
SAFETY - PRICE ++

COMFORT LINE

■ Mid-density high-resilience polyurethane foam 25-30 kg/m³

■ Low-density polyurethane foam 21-25 kg/m³

BM300HR



ADVANTAGES

COMFORT ++ LIFESPAN +++
SAFETY +++ PRICE +++

■ Mid-density polyurethane foam 30-35 kg/m³

■ Low-density polyurethane foam 21-25 kg/m³

BM400HR



ADVANTAGES

COMFORT +++ LIFESPAN +++
SAFETY +++ PRICE ++

ROPE WALL MATS

Our standard rope wall mats feature a thick layer of heavy open cell polyurethane foam or a combination of a closed cell carpet bonded foam with an open cell foam.

FEATURES:

- Good walking stiffness.
- Good protection for falls of up to 3 m (10 ft)



CONFIGURATIONS

MODULAR VINYL PADDING



FEATURES:

- Total thickness between 10 and 20 cm (4-8")
- Softer for walking and on impact (from up to 3m/10ft)
- Easily removable for access
- Removable modular PVC vinyl cases
- Compliant with AS 2316.1
- Compliant with NF P90-312

ADDITIONAL OPTIONS:

- Higher fire rating PVC Vinyl cover

CARPET-BONDED FLOORING



FEATURES:

- Total thickness between 10 and 20 cm (4-8")
- Harder for walking and on impact (from up to 3m/10ft)
- Non-removable flooring
- Compliant with AS 2316.1
- Compliant with NF P90-312

ADDITIONAL OPTIONS:

- Anti-static connections

CONSTRUCTION & THICKNESS

SAFETY ZONE

CURRENT SAFETY STANDARD

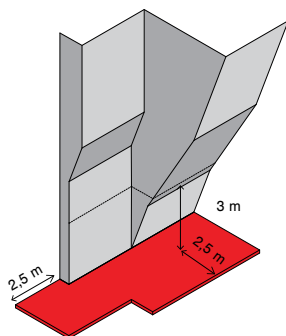

THE CLIMBAT STANDARD

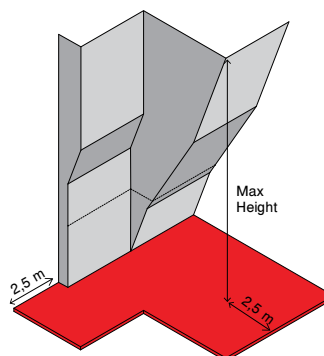

MODULAR VINYL PADDING

XPE+EPDM foam 34 kg/m³

RM 60



ADVANTAGES

WALKING STIFFNESS ⊕ ⊕ ⊕ LIFESPAN ⊕
SAFETY ⊕ PRICE ⊕

PURPOSE: Protection up to first belay point.
EN1177/ASTM F355 CFH*: 2.5 m

XPE+EPDM foam 34 kg/m³

High density polyurethane foam

RM 100

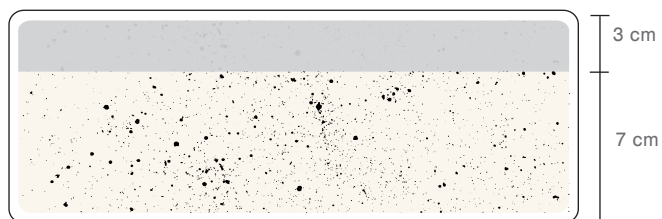

ADVANTAGES

WALKING STIFFNESS ⊕ ⊕ LIFESPAN ⊕ ⊕
SAFETY ⊕ PRICE ⊕ ⊕

PURPOSE: Protection up to first belay point.
EN1177/ASTM F355 CFH*: 3.0 m

CARPET-BONDED FLOORING

Carpet laminated XPE+EPDM foam 34 kg/m³

High density polyurethane foam

RM 100 / RM4"

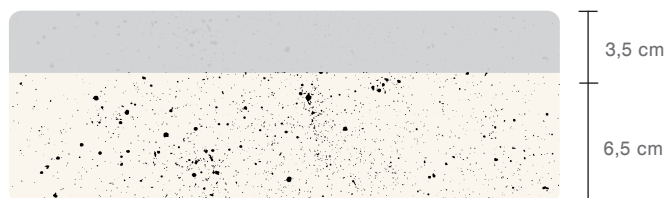

ADVANTAGES

WALKING STIFFNESS ⊕ ⊕ LIFESPAN ⊕ ⊕ ⊕
SAFETY ⊕ ⊕ PRICE ⊕ ⊕

PURPOSE: Protection up to first belay point, and above.
EN1177/ASTM F355 CFH*: 5.0 – 7.0 m**

Carpet laminated XPE+EPDM foam 34 kg/m³

High density polyurethane foam

RM 150 / RM6"



ADVANTAGES

WALKING STIFFNESS ⊕ ⊕ LIFESPAN ⊕ ⊕ ⊕
SAFETY ⊕ ⊕ ⊕ PRICE ⊕ ⊕

PURPOSE: Protection up to first belay point, and above.
EN1177/ASTM F355 CFH*: 7.0 – 9.0 m**

* CFH is the Critical Fall Height, measured as per the tests described in EN1177/ASTM F355. As it is mentioned in the standard, even though the EN1177, CFH test is not an accurate representation of a person falling from a height greater than 3 meters, it could be used to assess the energy absorbing capacity of safety flooring. Thus comparing the different types to one another.

** Depending on the polyurethane foam used.

ONE MORE LIFE



One More Life is innovative flooring solution for indoor top rope and lead climbing walls that prevents severe injuries or death in the event of a fall from up to 17 m / 55 ft.



ONE MORE LIFE STRUCTURE

WALK FRIENDLY SURFACE LAYER:

provides a stiff walking surface

LOW IMPACT ENERGY ABSORBING LAYER

safely absorbing the energy of multiple falls from up to 3m / 10 ft

HIGH IMPACT ENERGY ABSORBING LAYER

sacrifice module that safely absorbs the energy of falls from heights greater than 3m / 10 ft and up to 17m / 55 ft. The crushed modules need to be replaced.

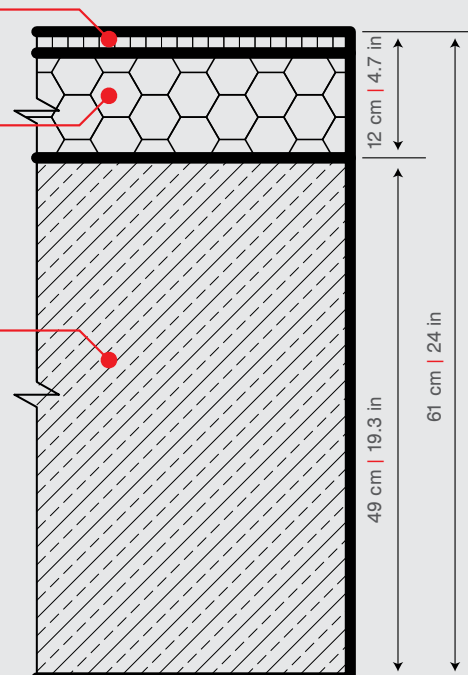

ONE MORE LIFE ENERGY ABSORPTION



Up to 3 m / 10 ft

In the event of a fall from less than 3m / 10ft, One More Life will sustain no damage.

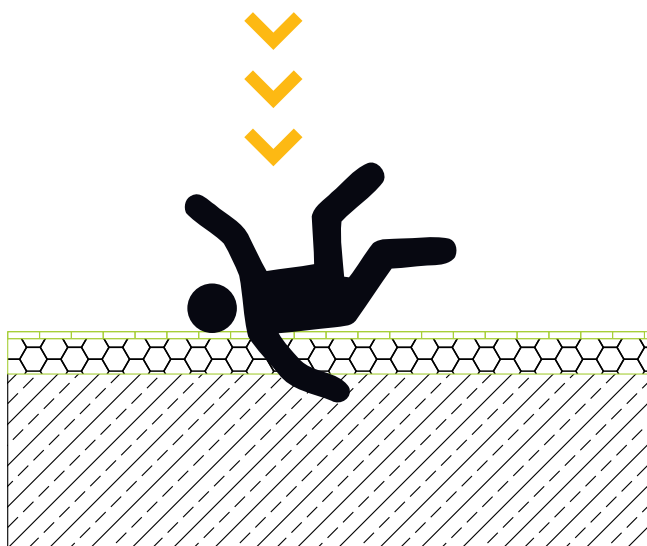

3 m / 10 ft to 17 m / 55 ft

In the event of a fall from more than 3m / 10 ft, the high impact energy absorbing modules of One More Life must be inspected for damage and the crushed modules must be replaced.

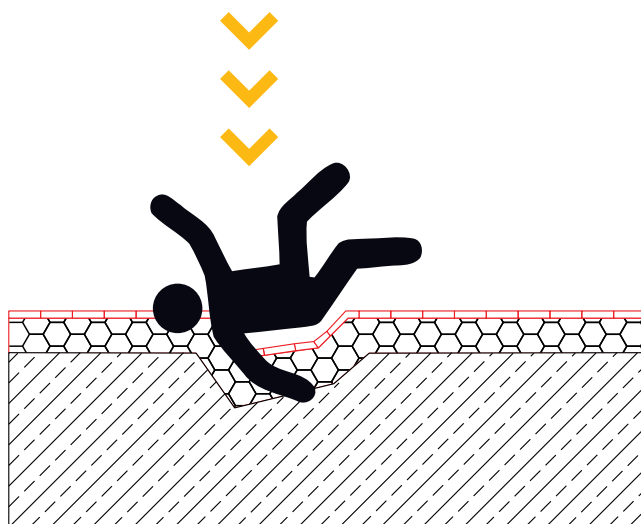

CONFIGURATIONS

OML 7



FEATURES:

- Total thickness 33 cm (13")
- Suitable for wall heights up to 7 m (23 ft)
- Non-removable flooring
- Carpet-bonded foam top layer
- Tests following US NHTSA standard for sudden impact
- CBF cover
- EN1177/ASTM F355 CFH: >8 m

ADDITIONAL OPTIONS:

- PVC Vinyl cover
- Portion of the surface can be made modular, for boom lift access

OML 12



FEATURES:

- Total thickness 47 cm (18.5")
- Suitable for wall heights up to 12m (39 ft)
- Non-removable flooring
- Carpet-bonded foam top layer
- Tests following US NHTSA standard for sudden impact
- CBF cover
- EN1177/ASTM F355 CFH: >8 m

ADDITIONAL OPTIONS:

- PVC Vinyl cover
- Portion of the surface can be made modular, for boom lift access

OML 17



FEATURES:

- Total thickness 63 cm (25")
- Suitable for wall heights up to 17m (55 ft)
- Non-removable flooring
- Carpet-bonded foam top layer
- Tests following US NHTSA standard for sudden impact
- CBF cover
- EN1177/ASTM F355 CFH: >8 m

ADDITIONAL OPTIONS:

- PVC Vinyl cover
- Portion of the surface can be made modular, for boom lift access

ONE MORE LIFE TEST



TESTING PROCEDURE

There is no standard for such a type of safety surface. This is normal since One More Life is the first of its kind. In order to determine whether it is safe we follow the standards set by the car manufacturing industry using a Hybrid II crash test dummy. Those procedures and standards are applicable in the event of fall from considerable heights from artificial climbing structures since the speed reached at the point of contact with the ground are comparable with highway car speeds. For example, if falling from 17 m / 55 ft, a person will hit the ground with 65 km/h or 40 mph.

US NATIONAL HIGHWAY TRAFFIC SAFETY ADMINISTRATION (NHTSA)				
Type of Human	Male	Female	Child	Average
Highly Dangerous Impact Deceleration	75 g's	65 g's	50 g's	65 g's

The NHTSA (National Highway Traffic Safety Administration) standard for a sudden impact chest deceleration on a human that would cause severe injury or death is 65 g's for an average human.

TEST RESULTS

CHEST DECELERATION CURVE

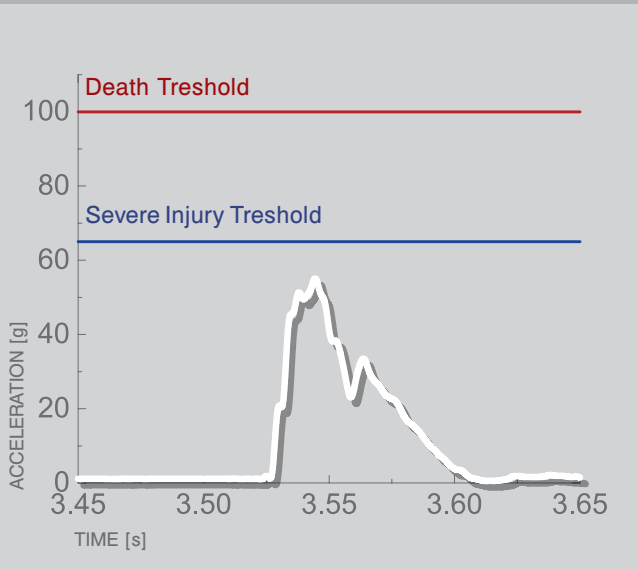

Human torso deceleration when falling on One More Life, from a height of 17 m. The maximum value is 55 g's.

HEAD DECELERATION CURVE

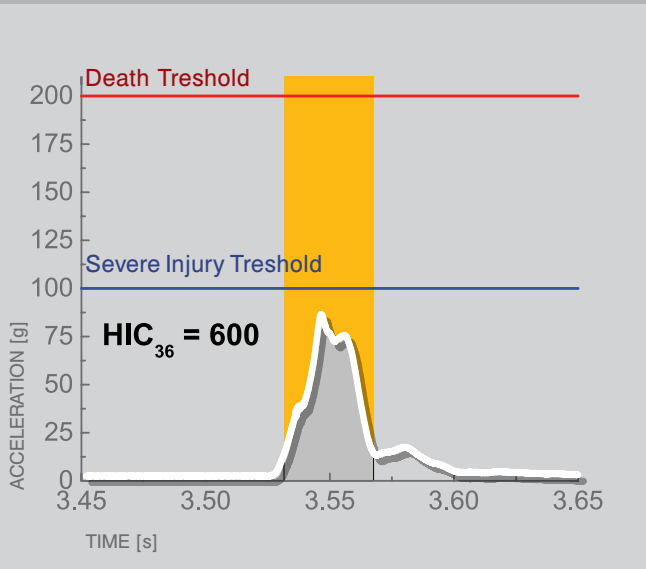

The average Head Injury Criterion (HIC) in such fall is 598, where the limit for HIC₃₆ is 1000.

A HIC₃₆ of 598 means that there is less than 5% chance for severe head injury and less than 60% chance for a moderate injury.



Those results are similar to car crashes with similar speeds, and are considered safe by the car industry standards, with significantly low risks for severe head of chest injuries and death.

ONE MORE LIFE TEST



SUMMARY OF TEST RESULTS FROM DIFFERENT HEIGHTS

FLOORING	HEIGHT OF FALL	IMPACT DECELERATION (G FORCE)	HEAD INJURY CRITERION (HIC)
ONE MORE LIFE	7m (23 ft)	35 g`s	520
ONE MORE LIFE	12 m (39 ft)	42 g`s	568
ONE MORE LIFE	17 m (55 ft)	58 g`s	598
NHTSA	-	65 g`s	1000

COMPARISON TO OTHER FLOOR SURFACES

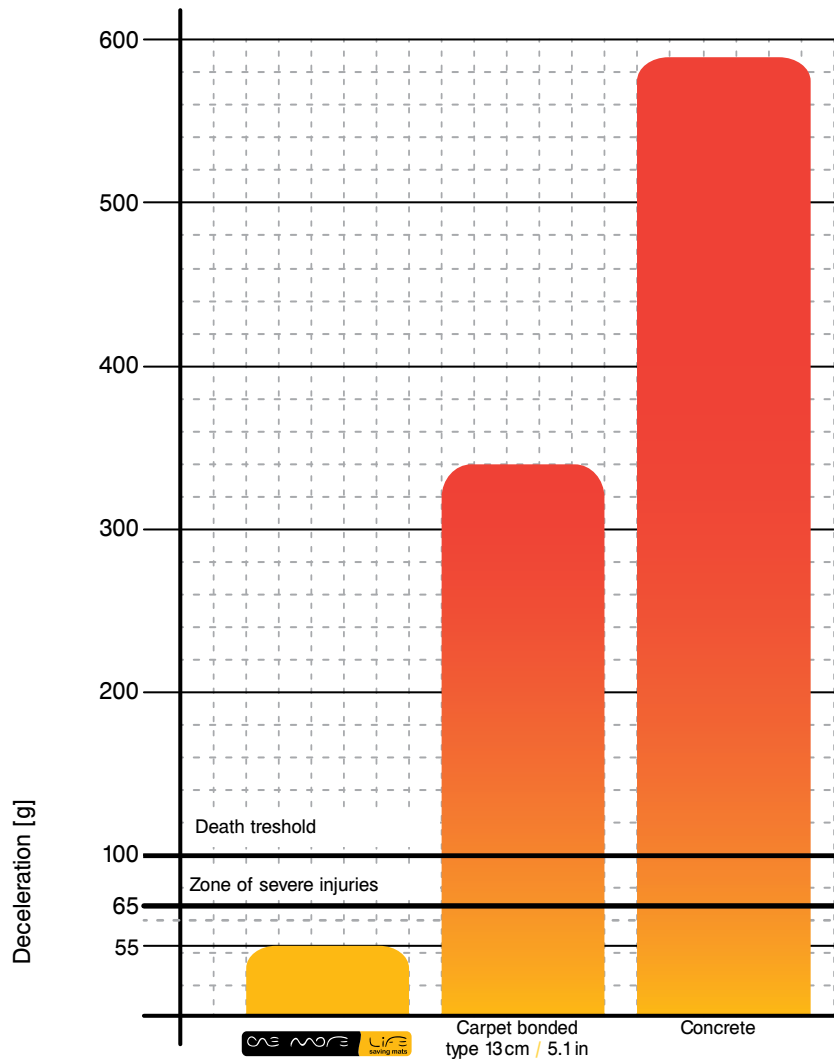

The table represents a fall from 17m / 55 ft on three different types of flooring.



CLIMBMAT OTHER PRODUCTS

Along with the flooring solution, we also offer a variety of products based on similar manufacturing technology. This includes protection mats for various adventure zones and sport centers, soft elements for the interactive climbing wall brand Fun Walls and many more.

NINJA COURSE



FUN WALLS ELEMENTS



PARKOUR ELEMENTS



SAFETY GATES



COMPLETED PROJECTS - CLIMBING

GRIP BOULDERHAL

Nijmegen, Netherlands

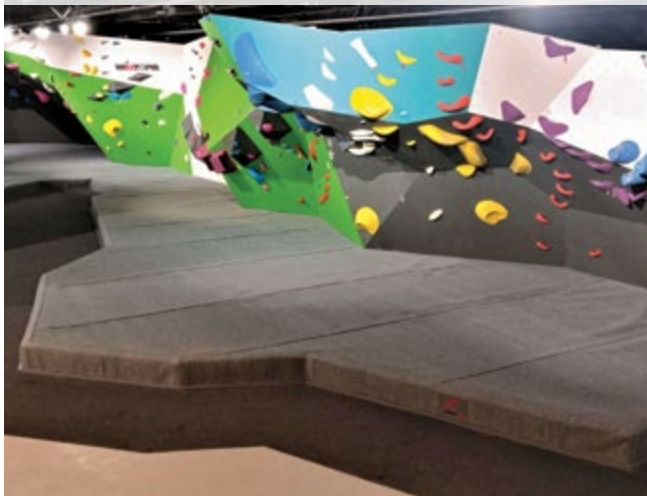

SPUTNIK CLIMBING CENTER

Madrid, Spain



GUSTAAF KLIMT

Turnhout, Belgium

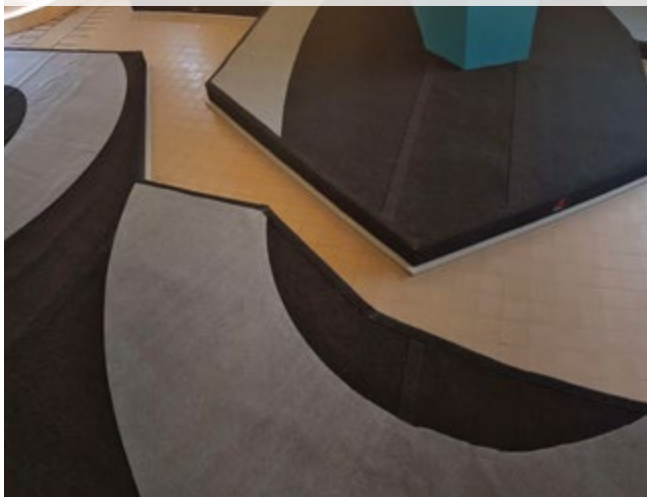

SHARMA CLIMBING

Madrid, Spain



CLIMBUP - PORTE D'ITALIE

Paris, France

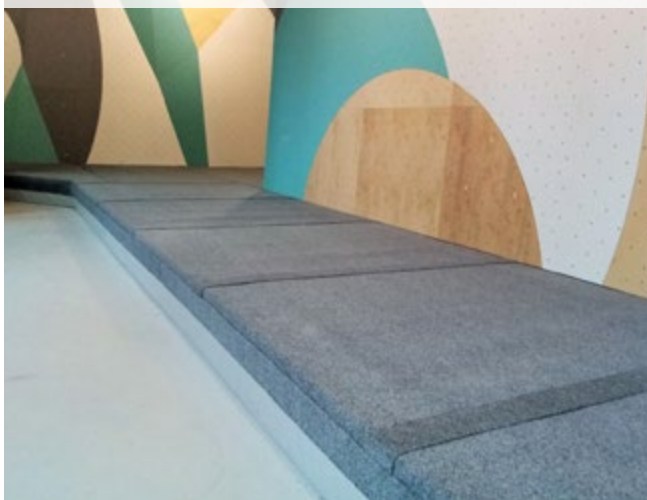

CLIMB ACADEMY

Sofia, Bulgaria

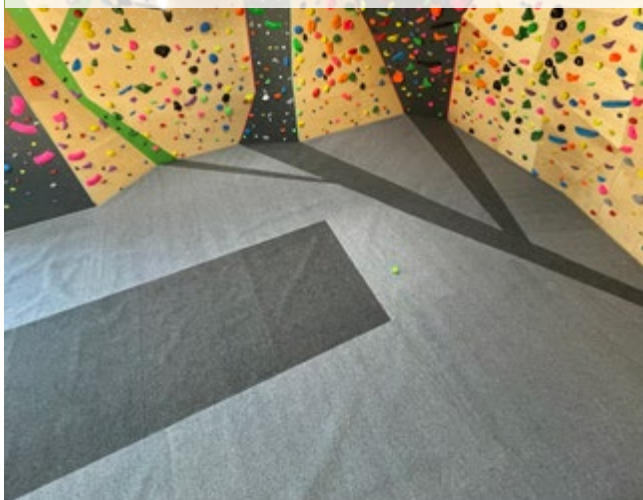

COMPLETED PROJECTS - CLIMBING

KRAFTREAKTOR BULDERHALLE

Lenzburg, Switzerland

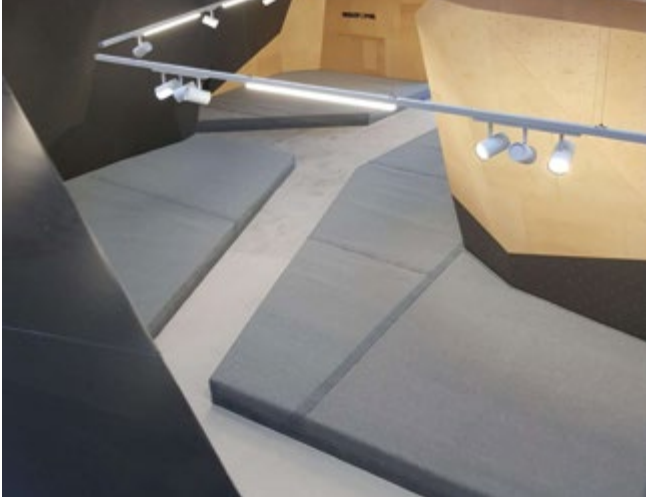

LANCASTER WALL

Lancaster, UK

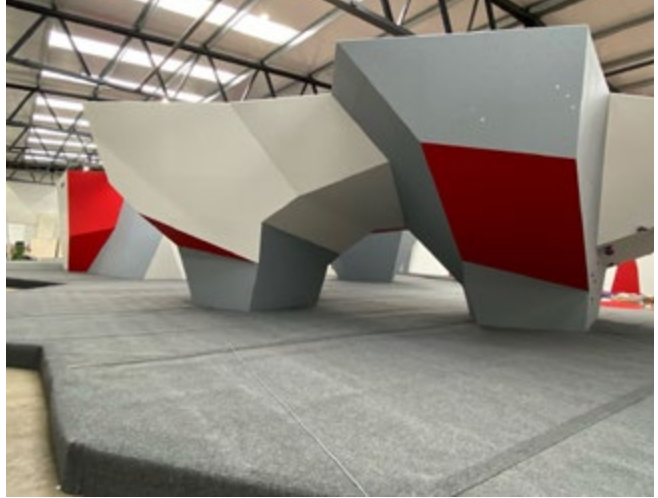

CITY BOULDERING

Aldgate, UK



MEMPHIS ROX

Memphis, TN, USA

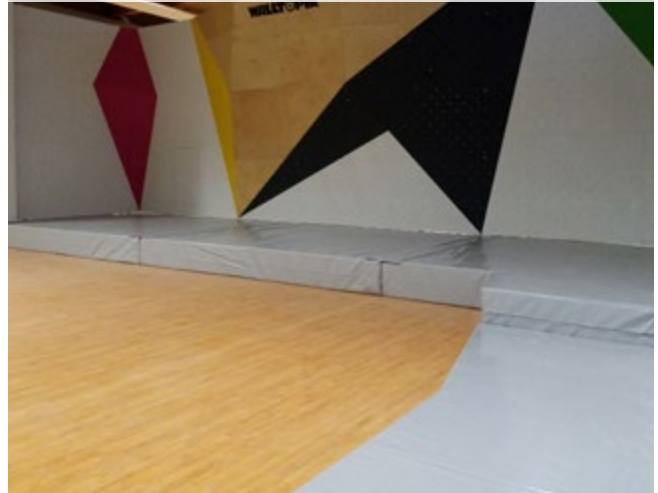

TOTEM MEYRIN

Meyrin, Switzerland



DYNO DETROIT

Detroit, MI, USA

